

Daikin Altherma 3 H MT & HT  
The Quintessence of heat pump  
**Product catalogue**



**Mid to high temperature air-to-water heat pump**  
Heating, cooling and domestic hot water



reddot design award  
winner 2019





# Table of contents

<b>The ideal boiler replacement</b> .....	<b>4</b>
<b>Daikin Altherma 3 H MT &amp; HT</b> .....	<b>6</b>
The Quintessence of heat pump .....	6
Innovation at the heart of our concerns.....	8
One solution, multiple combinations .....	10
Get the best comfort with the best functionalities.....	11
Floor standing unit with integrated tank .....	12
Floor standing unit with integrated ECH <sub>2</sub> O tank.....	20
Wall mounted unit .....	30
<b>Thermal stores and tanks</b> .....	<b>38</b>
Thermal stores .....	40
Domestic hot water tanks .....	41
<b>Heat pump convectors</b> .....	<b>40</b>
Daikin Altherma HPC floor standing .....	42
Daikin Altherma HPC wall mounted .....	44
Daikin Altherma HPC concealed .....	45
<b>Controls</b> .....	<b>46</b>
Onecta App .....	46
Madoka .....	48
<b>Stand By Me</b> .....	<b>50</b>
<b>Combination table and options</b> .....	<b>54</b>

# The ideal boiler replacement

Gets extended

## Ideal to replace gas boilers

Houses built in the 90s often need a refurbishment to still look up-to-date.

In a renovation project, this is also important to consider changing your initial heating system.

Daikin Altherma 3 H MT comes as a perfect replacement in such houses, where a leaving water temperature of 65 °C is sufficient. Easy to install, you can even leave the recent radiators installed!

## Suitable for medium sized new buildings

With a capacity range going from 8 to 12 class, Daikin Altherma 3 H MT also fits in medium sized new buildings.

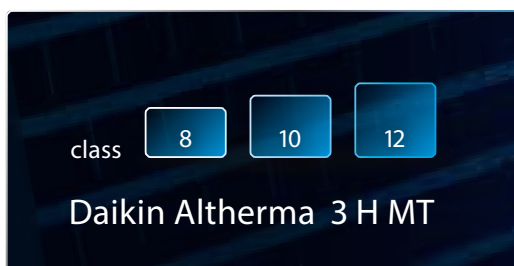



## Ideal to replace oil boilers

Daikin Altherma 3 H HT is a high temperature heat pump, able to deliver a leaving water temperature of 70 °C. Thanks to this operation range, the unit can replace oil boilers in older houses.

Traditional radiators can also stay in place, but more recent radiators could be a good option in order to make further energy savings.

## Suitable for large new buildings

With a capacity range going from 14 to 18 class, Daikin Altherma 3 H HT can answer the needs of large new buildings.

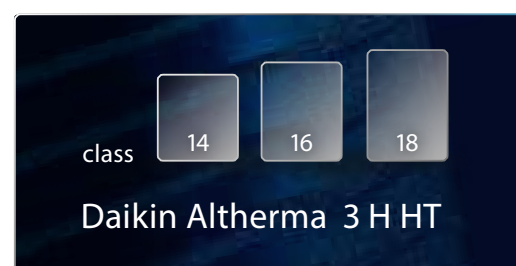

# The Quintessence of heat pump

meeting modern society's expectations



## Made in Europe, for Europe

European weather can be tough sometimes. That's why we designed the Daikin Altherma 3 H MT & HT.

Heating capacities are also maintained high by low ambient temperature thanks to genuine Daikin technology.

As the market leader, Daikin is always striving to make the most reliable and efficient heat pumps possible. Daikin developed the Bluevolution technology to achieve higher and greener performance. This technology is now part of all new products. The Daikin Altherma 3 H HT was the first Daikin outdoor unit with a distinctive design. Its single fan reduces the noise level and its black front grille makes the unit fit into any environment.

All these dedicated components were developed in-house to make the quintessence of heat pump unique.

**Superior performance, renewable energy use, design and acoustic comfort.**  
This is what the Quintessence of heat pump is all about.

## BLUEvolution

The Bluevolution technology combines a specifically developed compressor and the R-32 refrigerant. Daikin is one of the pioneers in the world to launch heat pumps equipped with R-32. With a lower Global Warming Potential (GWP), the R-32 is equivalent in power to standard refrigerants, but achieves higher energy efficiency and lower CO<sub>2</sub> emissions.

Easy to recover and re-use, R-32 is the perfect solution to attain the new European CO<sub>2</sub> emission targets.

**R-32**

## Timeless design and space-saving installation

Aside from the acoustic comfort, design is a decisive point nowadays. Specific attention was paid to making the outdoor unit blend in with your home.

The black front grille stretches horizontally making the fan inside invisible. The mat grey casing reflects the colour of the wall behind for more discretion. This unit received the IF and reddot design awards 2019.

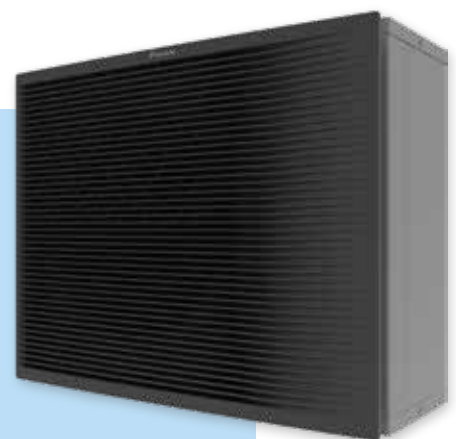

Witness a timeless design



## Silence rhymes with comfort

The Quintessence of heat pump has been designed to reduce its acoustic level and meet the expectations of today's society.

In standard sound mode, the unit produces a sound pressure of 38 dBA at 3 metres, so somewhere between birds chirping and the inside of a library.

The unit also offers greater flexibility by having a low sound mode that reduces the sound pressure at 3 metres to 35 dBA, representing a real reduction of half the sound level!

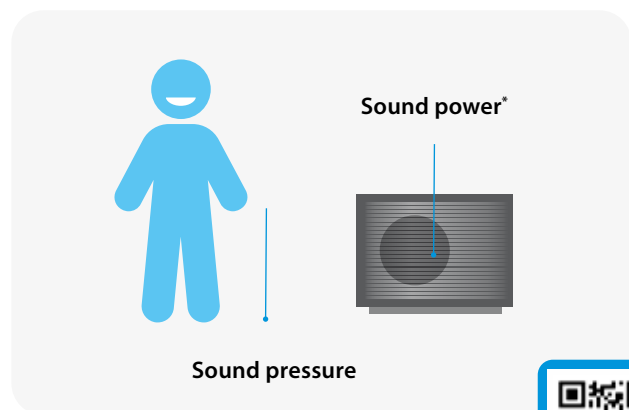
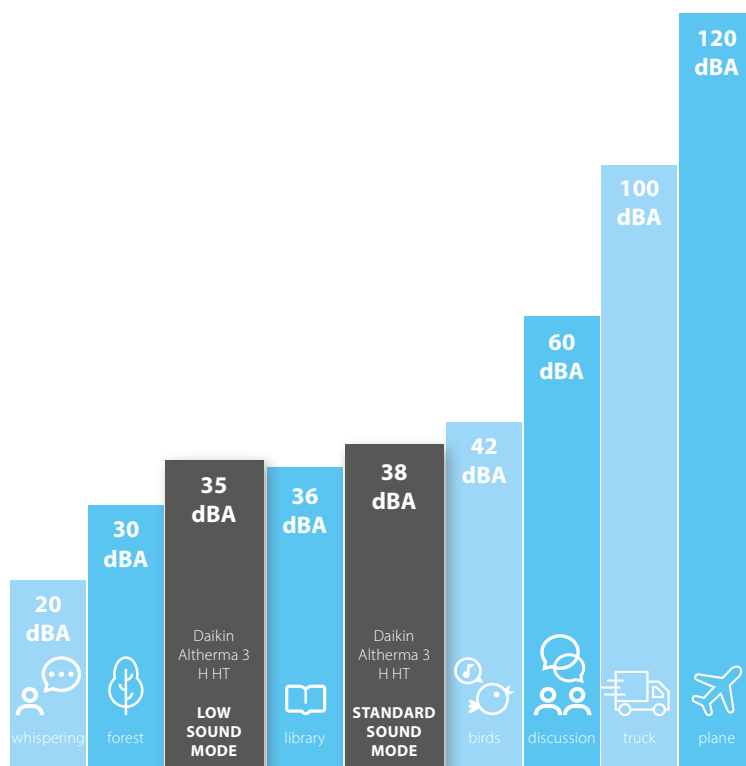

\* Erp sound power:  
 Daikin Altherma 3 H MT = 53 dBA  
 Daikin Altherma 3 H HT = 54 dBA

## The acoustic level can be evaluated in two ways

- › The **sound power** is generated by the unit itself, independently of distance and environment
- › The **sound pressure** is the sound perceived at a certain distance. The sound pressure is usually calculated at between 1 and 5 metres from the unit.



Listen to the silence of our outdoor unit

# Innovation At the heart of our concerns

The Daikin Altherma 3 H MT & HT are at top of low sound and heating performances thanks to dedicated developments. Several major components are designed to make this product reach the excellence such as a double injection compressor and a single fan even for large capacity units as well as a brand-new casing.

## A redesigned casing

The black front grille made of horizontal lines is hiding the fan from view, reducing the perception of the sound produced by the unit.

The light grey casing is slightly reflecting the environment where the unit is installed, helping it to blend in in any decor.

This unique design already got design awards.



reddot design award  
winner 2019

## A single fan for all capacities

The single fan is slightly larger, replacing the usual double fan for high capacity units (classes 8-10-12-14-16-18).

The shape of the fan has also been reviewed to reduce the contact surface with air therefore lower the sound level by improving the air circulation.

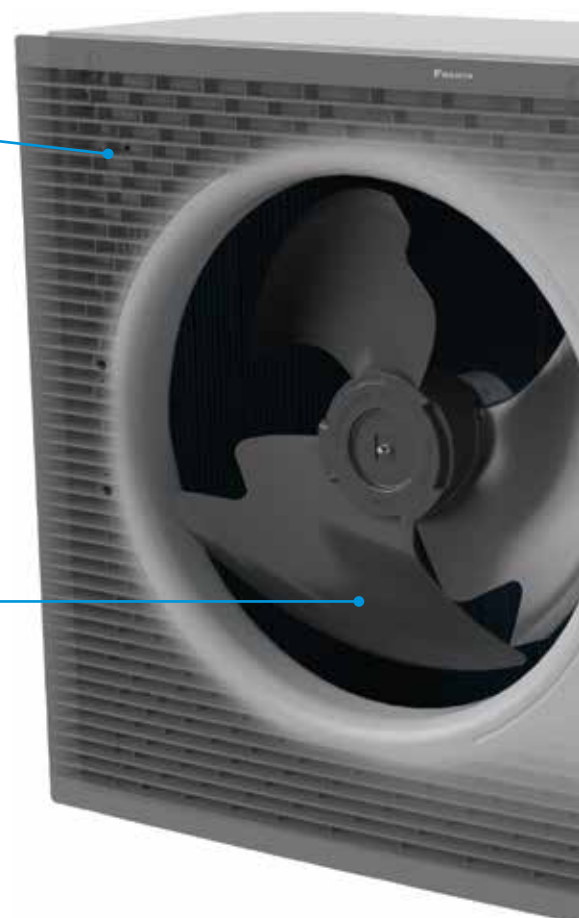



## Compressor insulation and anti-vibration

To reduce the compressor sound power, several actions were taken in terms of absorption and insulation.

First, the compressor is surrounded by a 3-layer insulation made of air, insulation material and a metal box.

Regarding the absorption, the unit benefits from a double sound reduction by using rubber pads between the bottom plate and the vibration plate under the compressor.

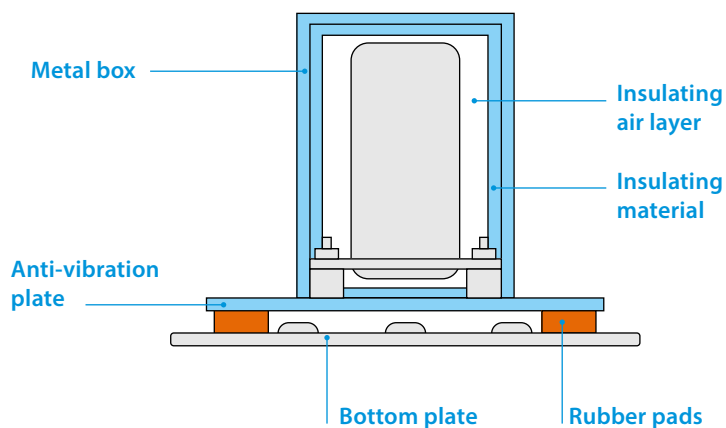

## New double injection compressor

To make this product unique, Daikin Europe cooperated with Daikin Japan to develop top notch components. The Daikin Altherma 3 H HT compressor is able to deliver a high leaving water temperature of 70 °C on its own, while the Daikin Altherma 3 H MT available in classes 8-10-12 delivers up to 65 °C leaving water temperature.

## Impressive performance

With these new developments, the Daikin Altherma 3 H MT & HT reach the best performances illustrated in the energy labels:



35 °C and 55 °C  
Space heating



up to



up to



Feel a true performance

# One solution, multiple combinations

The Quintessence range can be combined with three different indoor units to connect to the outdoor unit, offering specific features to ensure heating, cooling and domestic hot water in your home.

## Outdoor unit

The outdoor unit is available in 6 classes 8-10-12-14-16-18 kW.



## Integrated DHW stainless steel tank model

This model is a compact unit with a small footprint of 595x625 mm. The unit is equipped with a tank of 180 or 230 L to answer your domestic hot water demand.



## Integrated ECH<sub>2</sub>O DHW tank model

The ECH<sub>2</sub>O unit is equipped with a thermal DHW tank of 300 or 500 L that can be connected to thermal solar panels.



## Wall mounted model

This model is the most compact unit but needs to be with a separate tank to deliver domestic hot water.



See exact dimensions per model in the specification tables (p22-29).

# Get the best comfort

## with the best functionalities

Choose from the Daikin "Three Pluses" the functionality that best fits your customer's needs. The indoor units come in 3 possible versions: heating only, reversible and bizona, giving you the opportunity to tailor your Daikin heating system.

### + Heating only model

The heating only model is standard in the Daikin product range and is available for all three indoor units. This means that your heating system provides space heating and domestic hot water.

### + Reversible model

If cooling is needed, all three indoors have dedicated reversible models. Reversible means that the system can invert its way of working and provide cooling instead of heating. The cooling function requires a underfloor piping system or fan coil units.

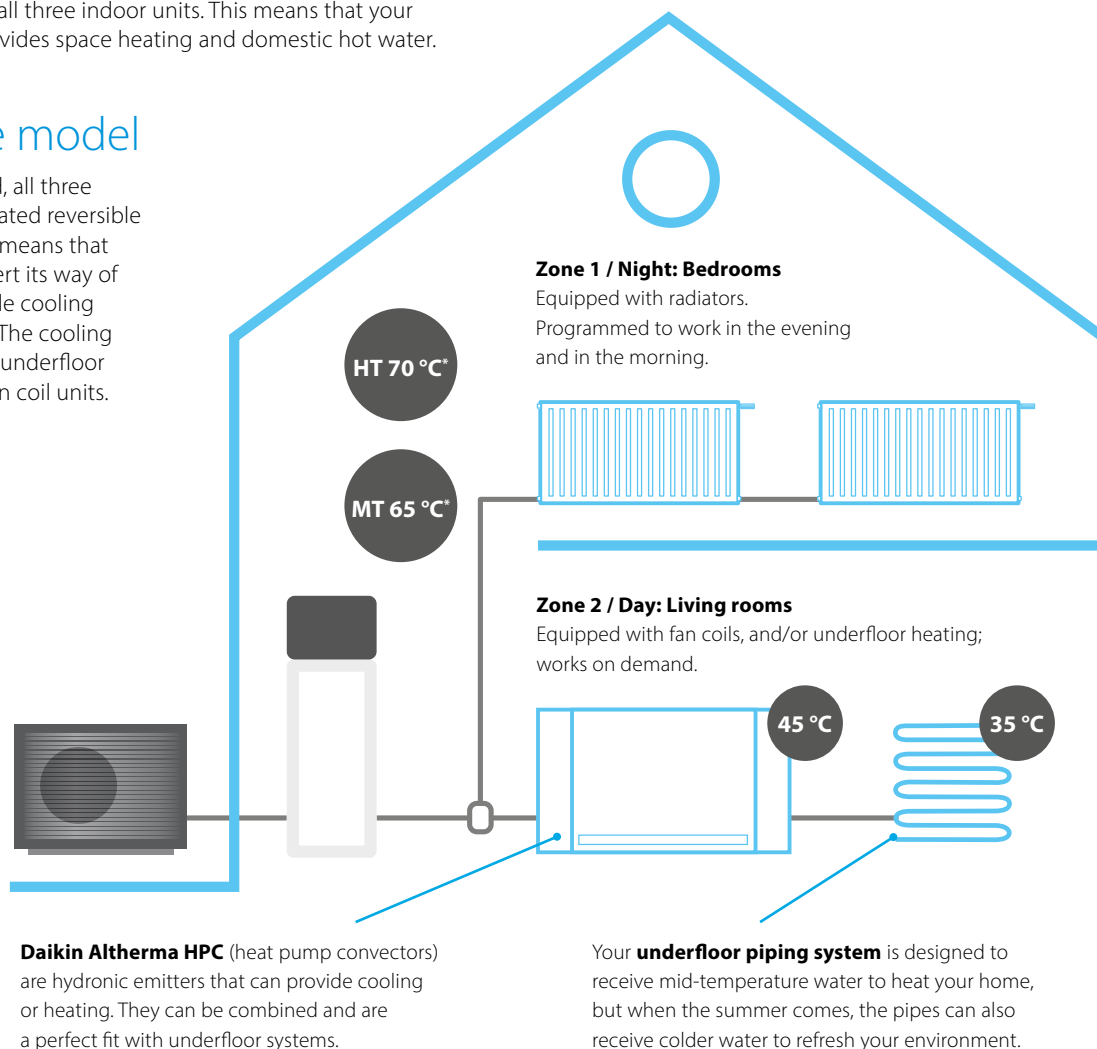

### + Bizona model

Only the DHW stainless steel tank model has a dedicated bizona model: you can choose two independent zones with different emitters that need a different temperature level in different rooms (example: underfloor system in the living room and radiators in the bedroom upstairs).

The 2 zones can also be managed independently: deactivate heating on the first floor during the day in order to reduce over consumption.

\* Daikin Altherma 3 H HT models produce a LWT up to 70 °C (14-16-18 classes). Daikin Altherma 3 H MT produces a LWT up to 65 °C (08-10-12 classes).



## Floor standing unit with integrated tank

### Why choose Daikin floor standing unit with integrated domestic hot water tank?

The Daikin Altherma 3 floor standing unit is the ideal system **to deliver heating, domestic hot water and cooling** for renovation or large new built.

#### All in one system to save installation space and time

- › A combined stainless steel domestic hot water tank of 180 or 230 L and heatpump ensures a faster installation compared to traditional systems.
- › Inclusion of all hydraulic components means no third party components are required.
- › PCB board and hydraulic components are located in the front for easy access
- › Small installation footprint of 595 x 625 mm
- › Integrated back-up heater choice of 6, 9 kW models are available
- › Dedicated bi-zone models allowing temperature monitoring for 2 zones.

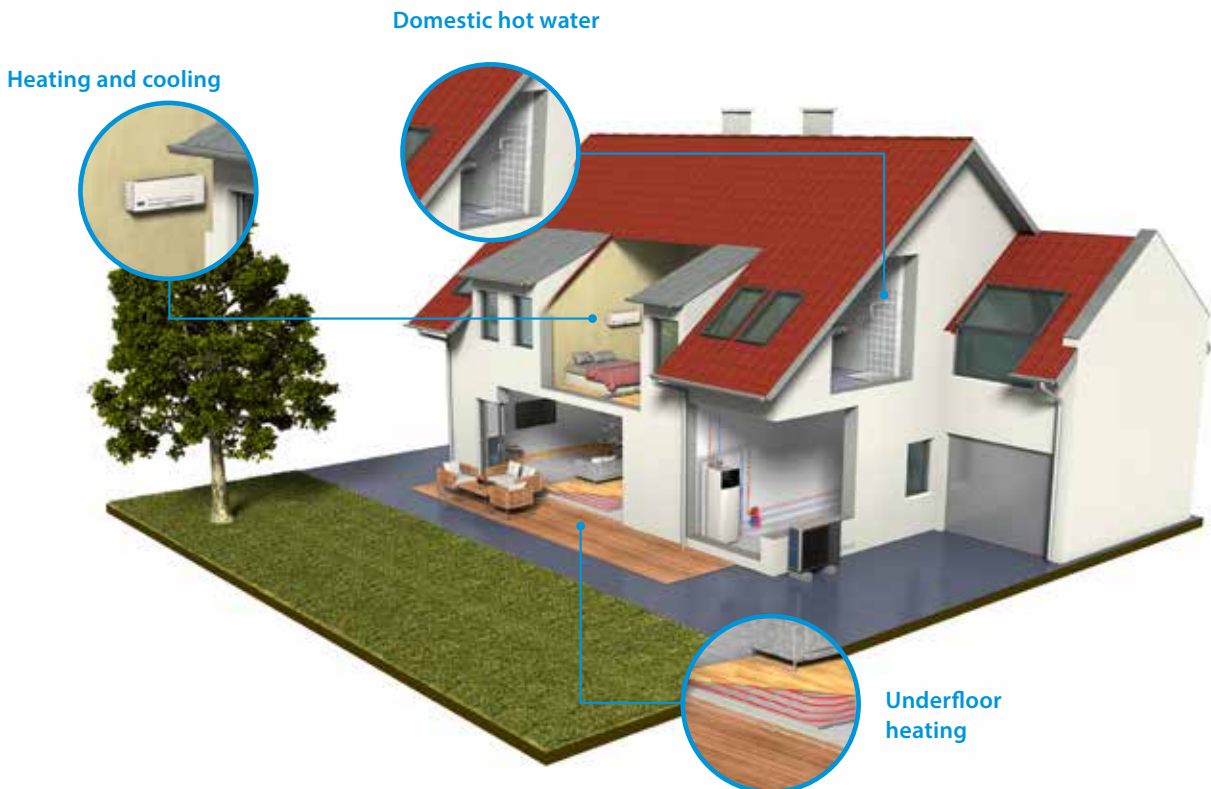

# All-in one design

## Reduces the installation footprint and height

Compared to the traditional split version for a wall mounted indoor unit and a separate domestic hot water tank, the integrated indoor unit greatly reduces the installation space required.

With a small footprint of 595 x 625 mm, the integrated indoor unit has a similar footprint when compared to other household appliances.

For installation projects, almost no side clearance is necessary as the piping is located at the top of the unit.

With an installation height of 1,65 m for an 180 L tank and 1,85 m for a 230 L tank, the required installation height is less than 2m.

The compactness of the integrated indoor unit is emphasised by its sleek design and modern look, easy blending in with other household appliances.

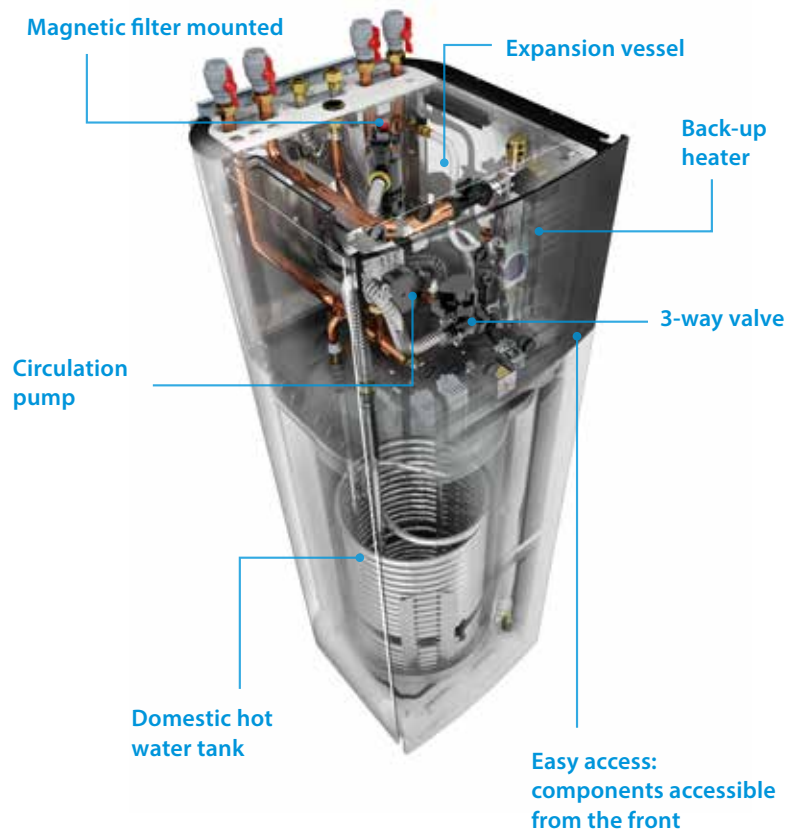

## Advanced user interface



### The Daikin Eye

The intuitive Daikin eye shows you in real time the status of your system.

Blue is perfect! Should the eye turn red, an error has occurred.

### Quick to configure

Log in and you'll be able to completely configure the unit via the new interface in less than 10 steps. You can even check if the unit is ready for use by running test cycles!

### Easy operation

Work super-fast with the new interface. It's super easy to use with just a few buttons and 2 navigational knobs.

### Beautiful design

The interface was especially designed to be very intuitive. The high contrasted colour screen delivers stunning and practical visuals that really help you as installer or service engineer.

## Integrated indoor unit



# Daikin Altherma 3 H MT F

## Floor standing air to water heat pump for heating and hot water

- › A combined stainless steel domestic hot water tank of 180 or 230 L and heat pump for easy installation
- › Inclusion of all hydraulic components means no third party components are required
- › PCB board and hydraulic components are located in the front for easy access
- › Small installation footprint of 595 x 625 mm
- › Integrated back-up heater of 6 or 9 kW
- › Heat pump operation down to -28 °C



Efficiency data				ETVH + EPRA		12S18E6V/E9W + 08EV/W	12S23E6V/E9W + 08EV/W	12S18E6V/E9W + 10EV/W	12S23E6V/E9W + 10EV/W	12S18E6V/E9W + 12EV/W	12S23E6V/E9W + 12EV/W
Space heating	Average climate water outlet 55 °C	General	SCOP			3.41 / 3.52				3.43 / 3.53	
			η <sub>s</sub> (Seasonal space heating efficiency)					134 / 138			
	Seasonal space heating eff. class					A++					
	Average climate water outlet 35 °C	General	SCOP			4.69 / 4.81		4.71 / 4.84		4.71 / 4.84	
		η <sub>s</sub> (Seasonal space heating efficiency)			184 / 190		186 / 191		186 / 191		
		Seasonal space heating eff. class					A+++				
Domestic hot water heating	Average climate	General	Declared load profile	L	XL	L	XL	L	XL	L	XL
			COP <sub>dhw</sub>	2.72 / 2.80	2.96 / 3.05	2.72 / 2.80	2.96 / 3.05	2.72 / 2.80	2.96 / 3.05		
	η <sub>wh</sub> (water heating efficiency)			117 / 120		126 / 130		117 / 120		126 / 130	
	Water heating energy efficiency class							A+			
Indoor Unit				ETVH		12S18E6V/E9W	12S23E6V/E9W	12S18E6V/E9W	12S23E6V/E9W	12S18E6V/E9W	12S23E6V/E9W
Casing	Colour			White + Black							
	Material			Precoated sheet metal							
Dimensions	Unit	HeightxWidthxDepth	mm	1,650x595x625	1,850x595x625	1,650x595x625	1,850x595x625	1,650x595x625	1,850x595x625	1,650x595x625	1,850x595x625
Weight	Unit			kg	108	117	108	117	108	117	
Tank	Water volume			l	180	230	180	230	180	230	
	Maximum water temperature			°C	70						
	Maximum water pressure			bar	10						
	Corrosion protection			Pickling							
Operation range	Heating	Ambient	Min.~Max.	°C	-28 ~ 25						
		Water side	Min.~Max.	°C	18 ~ 65						
	Domestic hot water	Ambient	Min.~Max.	°C	-28 ~ 35						
		Water side	Min.~Max.	°C	10 ~ 65						
Sound power level	Nom.			dBA	44						
Sound pressure level	Nom.			dBA	30						
Outdoor Unit				EPRA		08EV3/W1	10EV3/W1	12EV3/W1			
Dimensions	Unit	HeightxWidthxDepth	mm	1,003x1,270x533							
Weight	Unit			kg	118						
Compressor	Quantity			1							
	Type			Hermetically sealed swing compressor							
Operation range	Heating	Min.~Max.	°CDB	-28 ~ 25							
	Cooling	Min.~Max.	°CDB	10 ~ 43							
	Domestic hot water	Min.~Max.	°CDB	-28 ~ 35							
Refrigerant	Type			R-32							
	GWP			675							
	Charge			kg	3.25						
	Charge			TCO <sub>2</sub> Eq	2.19						
	Control			Expansion valve							
LW(A) Sound power level (according to EN14825)			53								
Sound pressure level (at 1 meter)	Nom.			40.6/41.1							
Power supply	Name/Phase/Frequency/Voltage			Hz/V							
Current	Recommended fuses			A							

This product contains fluorinated greenhouse gases.

# Daikin Altherma 3 H HT F

## Floor standing air to water heat pump for heating and hot water

- › A combined stainless steel domestic hot water tank of 180 or 230 L and heat pump for easy installation
- › Inclusion of all hydraulic components means no third party components are required
- › PCB board and hydraulic components are located in the front for easy access
- › Small installation footprint of 595 x 625 mm
- › Integrated back-up heater of 6 or 9 kW
- › Heat pump operation down to -28 °C



011-1W0353-354  
011-1W0357-358  
011-1W0361-362

Efficiency data				ETVH + EPRA	16S18E6V7/E9W7 + 14DV7/W7	16S23E6V7/E9W7 + 14DV7/W7	16S18E6V7/E9W7 + 16DV7/W7	16S23E6V7/E9W7 + 16DV7/W7	16S18E6V7/E9W7 + 18DV7/W7	16S23E6V7/E9W7 + 18DV7/W7
Space heating	Average climate water outlet 55 °C	General	SCOP	3.58 / 3.57						
			ηs (Seasonal space heating efficiency)	140						
	Average climate water outlet 35 °C	General	SCOP	4.51 / 4.71						
			ηs (Seasonal space heating efficiency)	177 / 186						
Domestic hot water heating	General	Declared load profile	Seasonal space heating eff. class	A+++						
			COPdhw	L						
	Average climate	COPdhw	ηjwh (water heating efficiency)	110 / 106	108 / 107	110 / 106	108 / 107	110 / 106	108 / 107	
			Water heating energy efficiency class	A						
Indoor Unit				ETVH	16S18E6V7/E9W7	16S23E6V7/E9W7	16S18E6V7/E9W7	16S23E6V7/E9W7	16S18E6V7/E9W7	16S23E6V7/E9W7
Casing	Colour	White + Black								
	Material	Precoated sheet metal								
Dimensions	Unit	HeightxWidthxDepth	mm	1,650x595x625	1,850x595x625	1,650x595x625	1,850x595x625	1,650x595x625	1,850x595x625	
Weight	Unit		kg	109	118	109	118	109	118	
Tank	Water volume		l	180	230	180	230	180	230	
	Maximum water temperature		°C	70						
	Maximum water pressure		bar	10						
	Corrosion protection			Pickling						
Operation range	Heating	Ambient	Min.~Max.	°C						
		Water side	Min.~Max.	°C						
	Domestic hot water	Ambient	Min.~Max.	°C						
		Water side	Min.~Max.	°C						
Sound power level	Nom.		dBA	44						
Sound pressure level	Nom.		dBA	30						
Outdoor Unit				EPRA	14DV37/W17	16DV37/W17	18DV37/W17			
Dimensions	Unit	HeightxWidthxDepth	mm	1,003x1,270x533						
Weight	Unit		kg	146 / 151						
Compressor	Quantity			1						
	Type			Hermetically sealed scroll compressor						
Operation range	Heating	Min.~Max.	°CDB	-28 ~ 25						
	Cooling	Min.~Max.	°CDB	10 ~ 43						
	Domestic hot water	Min.~Max.	°CDB	-28 ~ 35						
Refrigerant	Type			R-32						
	GWP			675						
	Charge		kg	4.20						
	Charge		TCO <sub>2</sub> Eq	2.84						
	Control			Expansion valve						
LW(A) Sound power level (according to EN14825)				54						
Sound pressure level (at 1 meter)	Nom.			43.0					48.0	
Power supply	Name/Phase/Frequency/Voltage		Hz/V	V3/1~/50/230 / W1/3~/50/400						
Current	Recommended fuses		A	32/16						

This product contains fluorinated greenhouse gases.

# Daikin Altherma 3 H MT F

Floor standing air to water heat pump for heating, cooling and hot water

- › A combined stainless steel domestic hot water tank of 180 or 230 L and heat pump for easy installation
- › Inclusion of all hydraulic components means no third party components are required
- › PCB board and hydraulic components are located in the front for easy access
- › Small installation footprint of 595 x 625 mm
- › Integrated back-up heater of 6 or 9 kW
- › Heat pump operation down to -28 °C



- 011-1W0503
- 011-1W0504
- 011-1W0505
- 011-1W0506
- 011-1W0507
- 011-1W0508

Efficiency data			ETVX + EPRA	12S18E6V/E9W + 08EV/W	12S23E6V/E9W + 08EV/W	12S18E6V/E9W + 10EV/W	12S23E6V/E9W + 10EV/W	12S18E6V/E9W + 12EV/W	12S23E6V/E9W + 12EV/W
Space heating	Average climate water outlet 55 °C	General	SCOP	3.47 / 3.59		3.48 / 3.60			
		Seasonal space heating eff. class	%	136 / 141		A++			
	Average climate water outlet 35 °C	General	SCOP	4.79 / 4.95		4.82 / 4.98			
		Seasonal space heating eff. class	%	188 / 195		190 / 196			
Domestic hot water heating	General	Declared load profile		A+++ L					
	Average climate	COP <sub>dhw</sub>	%	2.72 / 2.80	2.96 / 3.05	2.72 / 2.80	2.96 / 3.05	2.72 / 2.80	2.96 / 3.05
		η <sub>wh</sub> (water heating efficiency)	%	117 / 120	126 / 130	117 / 120	126 / 130	117 / 120	126 / 130
		Water heating energy efficiency class		A+					

Indoor Unit			ETVX	12S18E6V/D9W	12S23E6V/D9W	12S18E6V/D9W	12S23E6V/D9W	12S18E6V/D9W	12S23E6V/D9W
Casing	Colour	White + Black							
	Material	Precoated sheet metal							
Dimensions	Unit	HeightxWidthxDepth	mm	1,650x595x625	1,850x595x625	1,650x595x625	1,850x595x625	1,650x595x625	1,850x595x625
Weight	Unit	kg							
Tank	Water volume	l							
	Maximum water temperature	°C							
	Maximum water pressure	bar							
	Corrosion protection	Pickling							
Operation range	Heating	Ambient	Min.~Max.	°C					
		Water side	Min.~Max.	°C					
	Cooling	Ambient	Min.~Max.	°C					
		Water side	Min.~Max.	°C					
	Domestic hot water	Ambient	Max.	°C					
		Water side	Min.~Max.	°C					
Sound power level	Nom.	dBA							
Sound pressure level	Nom.	dBA							

Outdoor Unit			EPRA	08EV3/W1	10EV3/W1	12EV3/W1
Dimensions	Unit	HeightxWidthxDepth	mm	1,003x1,270x533		
Weight	Unit	kg				
Compressor	Quantity	1				
	Type	Hermetically sealed swing compressor				
Operation range	Heating	Min.~Max.	°CDB			
	Cooling	Min.~Max.	°CDB			
	Domestic hot water	Min.~Max.	°CDB			
Refrigerant	Type	R-32				
	GWP	675				
	Charge	kg				
	Charge	TCO <sub>2</sub> Eq				
	Control	Expansion valve				
LW(A) Sound power level (according to EN14825)	53					
Sound pressure level (at 1 meter)	Nom.	40.6/41.1				
Power supply	Name/Phase/Frequency/Voltage	Hz/V				
Current	Recommended fuses	A				

This product contains fluorinated greenhouse gases.



# Daikin Altherma 3 H HT F

Floor standing air to water heat pump for heating, cooling and hot water

- › A combined stainless steel domestic hot water tank of 180 or 230 L and heat pump for easy installation
- › Inclusion of all hydraulic components means no third party components are required
- › PCB board and hydraulic components are located in the front for easy access
- › Small installation footprint of 595 x 625 mm
- › Integrated back-up heater of 6 or 9 kW
- › Heat pump operation down to -28 °C



011-1W0353-354  
011-1W0357-358  
011-1W0361-362

Efficiency data				ETVX + EPRA		16S18E6V7/E9W7 + 14DV7/W7	16S23E6V7/E9W7 + 14DV7/W7	16S18E6V7/E9W7 + 16DV7/W7	16S23E6V7/E9W7 + 16DV7/W7	16S18E6V7/E9W7 + 18DV7/W7	16S23E6V7/E9W7 + 18DV7/W7
Space heating	Average climate water outlet 55 °C	General	SCOP	3.62 / 3.63							
			ηs (Seasonal space heating efficiency) %	142							
	Average climate water outlet 35 °C	General	SCOP	4.57 / 4.81							
			ηs (Seasonal space heating efficiency) %	180 / 190							
			Seasonal space heating eff. class	A+++							
Domestic hot water heating	General	Declared load profile		L	XL	L	XL	L	XL	L	XL
		COPdhw	2.62 / 2.51	2.61 / 2.55	2.62 / 2.51	2.61 / 2.55	2.62 / 2.51	2.61 / 2.55			
	Average climate	ηwh (water heating efficiency) %	110 / 106	108 / 107	110 / 106	108 / 107	110 / 106	108 / 107			
				Water heating energy efficiency class	A						

Indoor Unit				ETVX	16S18E6V7/E79W7	16S23E6V7/E79W7	16S18E6V7/E79W7	16S23E6V7/E79W7	16S18E6V7/E79W7	16S23E6V7/E79W7
Casing	Colour	White + Black								
	Material	Precoated sheet metal								
Dimensions	Unit	HeightxWidthxDepth	mm	1,650x595x625	1,850x595x625	1,650x595x625	1,850x595x625	1,650x595x625	1,850x595x625	
Weight	Unit		kg	109	118	109	118	109	118	
Tank	Water volume		l	180	230	180	230	180	230	
	Maximum water temperature		°C	70						
	Maximum water pressure		bar	10						
	Corrosion protection			Pickling						
Operation range	Heating	Ambient	Min.~Max.	°C						
		Water side	Min.~Max.	°C						
	Cooling	Ambient	Min.~Max.	°C						
		Water side	Min.~Max.	°C						
	Domestic hot water	Ambient	Max.	°C						
		Water side	Min.~Max.	°C						
Sound power level	Nom.		dBA	44						
Sound pressure level	Nom.		dBA	30						

Outdoor Unit				EPRA	14DV37/W17	16DV37/W17	18DV37/W17
Dimensions	Unit	HeightxWidthxDepth	mm		1,003x1,270x533		
Weight	Unit		kg	146/151			
Compressor	Quantity			1			
	Type			Hermetically sealed scroll compressor			
Operation range	Heating	Min.~Max.	°CDB	-28 ~ 25			
	Cooling	Min.~Max.	°CDB	10 ~ 43			
	Domestic hot water	Min.~Max.	°CDB	-28 ~ 35			
Refrigerant	Type			R-32			
	GWP			675			
	Charge		kg	4.20			
	Charge		TCO <sub>2</sub> Eq	2.84			
	Control			Expansion valve			
LW(A) Sound power level (according to EN14825)				54			
Sound pressure level (at 1 meter)	Nom.			43.0		48.0	
Power supply	Name/Phase/Frequency/Voltage		Hz/V	V3/1~/50/230 / W1/3~/50/400			
Current	Recommended fuses		A	32/16			

This product contains fluorinated greenhouse gases.

# Daikin Altherma 3 H MT F

Floor standing integrated with **two different temperature zones monitoring**

- › A combined stainless steel domestic hot water tank of 180 or 230 L and heat pump for easy installation
- › Inclusion of all hydraulic components means no third party components are required
- › PCB board and hydraulic components are located in the front for easy access
- › Small installation footprint of 595 x 625 mm
- › Integrated back-up heater of 6 or 9 kW
- › Heat pump operation down to -28 °C



Efficiency data				ETVZ + EPRA	12S18E6V/E9W + 08EV/W	12S23E6V/E9W + 08EV/W	12S18E6V/E9W + 10EV/W	12S23E6V/E9W + 10EV/W	12S18E6V/E9W + 12EV/W	12S23E6V/E9W + 12EV/W
Space heating	Average climate water outlet 55 °C	General	SCOP	3.41 / 3.52			3.43 / 3.53			
		ηs (Seasonal space heating efficiency)	%	134 / 138						
	Seasonal space heating eff. class			A++						
	Average climate water outlet 35 °C	General	SCOP	4.69 / 4.82			4.71 / 4.69		4.71 / 4.84	
ηs (Seasonal space heating efficiency)		%	184 / 190		186 / 184		186 / 191			
Seasonal space heating eff. class			A+++							
Domestic hot water heating	General	Declared load profile		L						
	Average climate	COPdhw	2.72 / 2.80		2.96 / 3.05		2.72 / 2.80		2.96 / 3.05	
		ηwh (water heating efficiency)	%	117 / 120		126 / 130		117 / 120		126 / 130
	Water heating energy efficiency class			A+						
Indoor Unit				ETVZ	12S18E6V/E9W	12S23E6V/E9W	12S18E6V/E9W	12S23E6V/E9W	12S18E6V/E9W	12S23E6V/E9W
Casing	Colour	White + Black								
	Material	Precoated sheet metal								
Dimensions	Unit	HeightxWidthxDepth	mm	1,650x595x625	1,850x595x625	1,650x595x625	1,850x595x625	1,650x595x625	1,850x595x625	
Weight	Unit	kg		114	122	114	122	114	122	
Tank	Water volume	l		180	230	180	230	180	230	
	Maximum water temperature	°C		70						
	Maximum water pressure	bar		10						
	Corrosion protection	Pickling								
Operation range	Heating	Ambient	Min.~Max.	°C		-28 ~ 25				
		Water side	Min.~Max.	°C		18 ~ 65				
	Domestic hot water	Ambient	Min.~Max.	°C		-28 ~ 35				
		Water side	Min.~Max.	°C		10 ~ 65				
Sound power level	Nom.	dBA		44						
Sound pressure level	Nom.	dBA		30						
Outdoor Unit				EPRA	08EV3/W1	10EV3/W1	12EV3/W1			
Dimensions	Unit	HeightxWidthxDepth	mm	1,003x1,270x533						
Weight	Unit	kg		118						
Compressor	Quantity	1								
	Type	Hermetically sealed swing compressor								
Operation range	Heating	Min.~Max.	°CDB		-28 ~ 25					
	Domestic hot water	Min.~Max.	°CDB		-28 ~ 35					
Refrigerant	Type	R-32								
	GWP	675								
	Charge	kg		3.25						
	Charge	TCO <sub>2</sub> Eq		2.19						
	Control	Expansion valve								
LW(A) Sound power level (according to EN14825)					53					
Sound pressure level (at 1 meter)	Nom.			40.6/41.1						
Power supply	Name/Phase/Frequency/Voltage	Hz/V		V3/1~/50/230 - W1/3~/50/400						
Current	Recommended fuses	A		32/16						

This product contains fluorinated greenhouse gases.

# Daikin Altherma 3 H HT F

Floor standing integrated with **two different temperature zones monitoring**

- › A combined stainless steel domestic hot water tank of 180 or 230 L and heat pump for easy installation
- › Inclusion of all hydraulic components means no third party components are required
- › PCB board and hydraulic components are located in the front for easy access
- › Small installation footprint of 595 x 625 mm
- › Integrated back-up heater of 6 or 9 kW
- › Heat pump operation down to -28 °C



011-1W0353-354  
011-1W0357-358  
011-1W0361-362

Efficiency data				ETVZ + EPRA	16S18E6V7/E9W7 + 14DV7/W7	16S23E6V7/E9W7 + 14DV7/W7	16S18E6V7/E9W7 + 16DV7/W7	16S23E6V7/E9W7 + 16DV7/W7	16S18E6V7/E9W7 + 18DV7/W7	16S23E6V7/E9W7 + 18DV7/W7	
Space heating	Average climate water outlet 55 °C	General	SCOP	3.58 / 3.57							
			ηs (Seasonal space heating efficiency) %	140							
	Seasonal space heating eff. class	A++									
	Average climate water outlet 35 °C	General	SCOP	4.51 / 4.71							
ηs (Seasonal space heating efficiency) %			177 / 186								
Seasonal space heating eff. class			A+++								
Domestic hot water heating	General	Declared load profile		L	XL	L	XL	L	XL		
		Average COPdhw	2.62 / 2.51		2.61 / 2.55		2.62 / 2.51		2.61 / 2.55		
	Climate	ηwh (water heating efficiency) %		110 / 106		108 / 107		110 / 106		108 / 107	
	Water heating energy efficiency class		A								
Indoor Unit				ETVZ	16S18E6V7/E9W7	16S23E6V7/E9W7	16S18E6V7/E9W7	16S23E6V7/E9W7	16S18E6V7/E9W7	16S23E6V7/E9W7	
Casing	Colour	White + Black									
	Material	Precoated sheet metal									
Dimensions	Unit	HeightxWidthxDepth	mm	1,650x595x625	1,850x595x625	1,650x595x625	1,850x595x625	1,650x595x625	1,850x595x625		
Weight	Unit	kg		120	128	120	128	120	128		
Tank	Water volume		l	180	230	180	230	180	230		
	Maximum water temperature		°C	70							
	Maximum water pressure		bar	10							
	Corrosion protection		Pickling								
Operation range	Heating	Ambient	Min.~Max.	°C							
		Water side	Min.~Max.	°C							
	Domestic hot water	Ambient	Min.~Max.	°C							
		Water side	Min.~Max.	°C							
Sound power level	Nom.	dBA		44							
Sound pressure level	Nom.	dBA		30							
Outdoor Unit				EPRA	14DV37/W17	16DV37/W17		18DV37/W17			
Dimensions	Unit	HeightxWidthxDepth	mm	1,003x1,270x533							
Weight	Unit	kg		146/151							
Compressor	Quantity		1								
	Type		Hermetically sealed scroll compressor								
Operation range	Heating	Min.~Max.	°CDB								
	Domestic hot water	Min.~Max.	°CDB								
Refrigerant	Type		R-32								
	GWP		675								
	Charge		kg								
	Charge		TCO <sub>2</sub> Eq								
	Control		Expansion valve								
LW(A) Sound power level (according to EN14825)				54							
Sound pressure level (at 1 meter)	Nom.	43.0							48.0		
Power supply	Name/Phase/Frequency/Voltage		Hz/V		V3/1~/50/230 / W1/3~/50/400						
Current	Recommended fuses		A		32/16						

This product contains fluorinated greenhouse gases.

## Floor standing unit with integrated ECH<sub>2</sub>O tank

The Daikin Altherma high temperature split integrated ECH<sub>2</sub>O is renowned for its ability to maximise renewable energy sources to provide the ultimate comfort in heating, domestic hot water and cooling

### Intelligent storage management

- › The unit is 'Smart Grid' ready to take advantage of low energy tariffs and efficiently store thermal energy for space heating and domestic hot water
- › Continuous heating during defrost mode and use of stored heat for space heating (500 L tank only)
- › Electronic management of both heat pump and ECH<sub>2</sub>O thermal store maximises energy efficiency, as well as convenient heating and domestic hot water
- › Achieves the highest standards for water sanitation
- › Uses more renewable energy with solar connection

- › Lightweight plastic tank
- › No corrosion, anode, scale or lime deposits
- › Contains impact resistant polypropylene inner and outer walls filled with high-grade insulation foam to reduce heat losses to a minimum

### Combinable with other heat sources

- › The bivalent option allows heat from other sources such as oil, gas or pellet-fired boilers to be stored in the solar system, further lowering energy consumption

### Innovative and high-quality tank

## ECH<sub>2</sub>O

Outdoor unit connection

Hydraulics

New controller display

Polypropylene tank



### Advanced user interface

#### The Daikin-Eye

The intuitive Daikin eye shows you in real time the status of your system. Blue is perfect! Should the eye turn red, an error has occurred.

#### Quick to configure

Log in and you'll be able to completely configure the unit in less than 10 steps. You can even check if the unit is ready for use by running test cycles!

#### Easy operation

The user interface works really fast thanks to its icon-based menus.

#### Beautiful design

The interface was especially designed to be very intuitive. The high contrasted colour screen delivers stunning and practical visuals that really help you as installer or service engineer.

## ECH<sub>2</sub>O thermal store range: additional hot water comfort

Combine your indoor unit with a thermal store to achieve the ultimate comfort at home.

- › Fresh water principle: receive domestic hot water on demand while eliminating the risk of contamination and sedimentation
- › Optimal domestic hot water performance: the low temperature evolution enables high tapping performance
- › Fit for the future: possibility to integrate with renewable solar energy and other heat sources, e.g. fireplace
- › Lightweight and robust build of the unit combined with the cascade principle offers flexible installation options

Built for small and large homes, customers can choose between a pressureless and a pressurised hot water system.

### Pressureless (drain-back) solar system (ETSH\*, ETSX\*)

- › The solar collectors are only filled with water when sufficient heating is provided by the sun
- › The pumps in the control and pump unit switch on briefly and fill the collectors with storage tank water
- › After filling, water circulation is maintained by the remaining pump

### Pressurised solar system (ETSHB\*, ETSXB\*)

- › System is filled with heat transfer fluid with the correct amount of antifreeze to avoid freezing in winter
- › System is pressurised and sealed

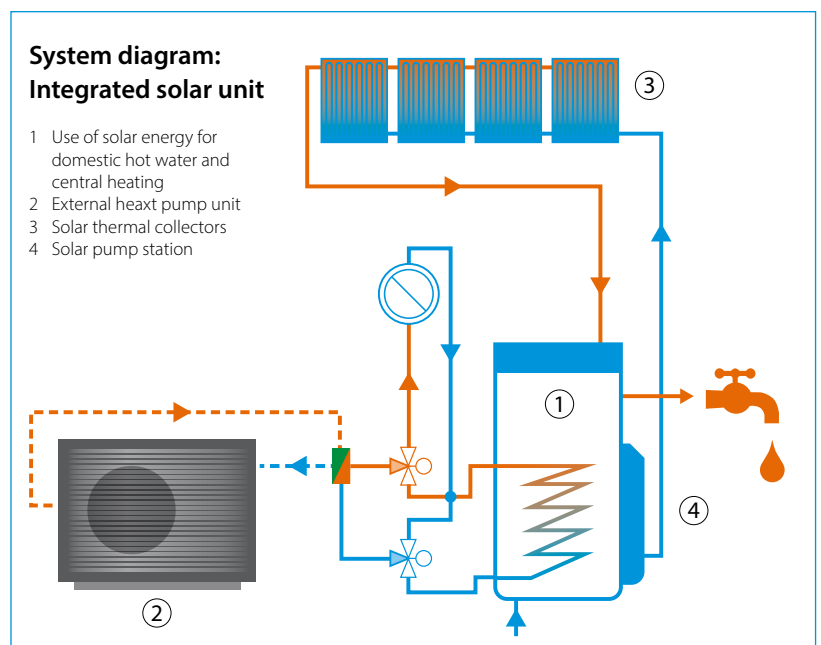
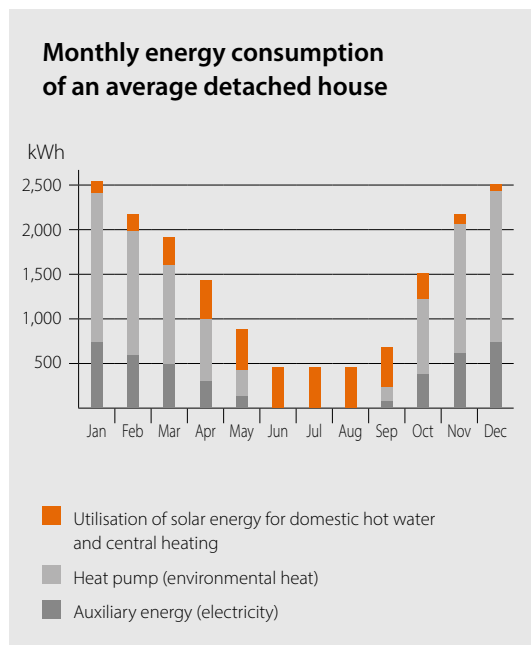

# Daikin Altherma 3 H MT ECH<sub>2</sub>O

Floor standing air-to-water heat pump for heating and hot water with thermal solar support

- › Integrated solar unit, offering top comfort in heating and hot water
- › Maximum use of renewable energy: uses heat pump technology for heating and solar support for space heating and domestic hot water production
- › Fresh water principle: hygienic water, with no need for thermal legionella disinfection
- › Maintenance-free tank: no corrosion, anode, scale or lime deposits, and no loss of water through safety valve
- › Solar support of domestic hot water with pressureless (drain-back) solar system
- › Heat loss is reduced to a minimum thanks to the high quality insulation
- › App control possible for managing heating, hot water and cooling operation
- › Heat pump operation down to -28 °C
- › Possible to connect to photovoltaic solar panels to provide energy for your heat pump



011-1W0501  
011-1W0502

Efficiency data		ETSH + EPRA		12P30E + 08EV/W	12P50E + 08EV/W	12P30E + 10EV/W	12P50E + 10EV/W	12P30E + 12EV/W	12P50E + 12EV/W
Space heating	Average climate water outlet 55 °C	General	SCOP	3.41 / 3.52		3.43 / 3.53			
			ηs (Seasonal space heating efficiency) %	134 / 138		A++			
		Seasonal space heating eff. class							
Domestic hot water heating	Average climate water outlet 35 °C	General	SCOP	4.69 / 4.81		4.71 / 4.84		4.71 / 4.84	
			ηs (Seasonal space heating efficiency) %	184 / 190		186 / 191		186 / 191	
		Seasonal space heating eff. class			A+++				
Domestic hot water heating	Average climate water outlet 35 °C	General	Declared load profile			L			
			COPdhw	2.75 / 2.83		3.10 / 3.17		2.75 / 2.83	
		ηwh (water heating efficiency) %	116 / 119		128 / 131		116 / 119		128 / 131
	Water heating energy efficiency class			A+					
Indoor Unit		ETSH		12P30E	12P50E	12P30E	12P50E	12P30E	12P50E
Casing	Colour	Traffic white (RAL9016) / Traffic black (RAL9017)							
	Material	Impact resistant polypropylene							
Dimensions	Unit	HeightxWidthxDepth	mm	1,892x594x644	1,910x792x816	1,892x594x644	1,910x792x816	1,892x594x644	1,910x792x816
Weight	Unit		kg	75	98	75	98	75	98
Tank	Water volume		l	294	477	294	477	294	477
	Maximum water temperature		°C	85					
Operation range	Heating	Ambient	Min.~Max.	-28 ~ 25					
		Water side	Min.~Max.	18 ~ 65					
	Domestic hot water	Ambient	Min.~Max.	-28 ~ 35					
		Water side	Min.~Max.	10 ~ 63					
Sound power level	Nom.		dBA	47.3					
Sound pressure level	Nom.		dBA	38.6					
Outdoor Unit		EPRA		08EV3/W1	10EV3/W1	12EV3/W1			
Dimensions	Unit	HeightxWidthxDepth	mm	1,003x1,270x533					
Weight	Unit		kg	118					
Compressor	Quantity			1					
	Type			Hermetically sealed swing compressor					
Operation range	Heating	Min.~Max.	°CDB	-28 ~ 25					
	Domestic hot water	Min.~Max.	°CDB	-28 ~ 35					
Refrigerant	Type			R-32					
	GWP			675					
	Charge		kg	3.25					
	Charge		TCO <sub>2</sub> Eq	2.19					
	Control			Expansion valve					
LW(A) Sound power level (according to EN14825)				53					
Sound pressure level (at 1 meter)	Nom.			40.6/41.1					
Power supply	Name/Phase/Frequency/Voltage		Hz/V	V3/1~/50/230 - W1/3~/50/400					
Current	Recommended fuses		A	32/16					

This product contains fluorinated greenhouse gases.

# Daikin Altherma 3 H HT ECH<sub>2</sub>O

Floor standing air-to-water heat pump for heating and hot water with thermal solar support

- › Integrated solar unit, offering top comfort in heating and hot water
- › Maximum use of renewable energy: uses heat pump technology for heating and solar support for space heating and domestic hot water production
- › Fresh water principle: hygienic water, with no need for thermal legionella disinfection
- › Maintenance-free tank: no corrosion, anode, scale or lime deposits, and no loss of water through safety valve
- › Solar support of domestic hot water with pressureless (drain-back) solar system
- › Heat loss is reduced to a minimum thanks to the high quality insulation
- › App control possible for managing heating, hot water and cooling operation
- › Heat pump operation down to -28 °C
- › Possible to connect to photovoltaic solar panels to provide energy for your heat pump



up to



Efficiency data				ETSH + EPRA	16P30E7 + 14DV7/W7	16P50E7+ 14DV7/W7	16P30E7 + 16DV7/W7	16P50E7 + 16DV7/W7	16P30E7 + 18DV7/W7	16P50E7 + 18DV7/W7
Space heating	Average climate water outlet 55 °C	General	SCOP	3.58 / 3.57						
			ηs (Seasonal space heating efficiency) %	140						
			Seasonal space heating eff. class	A++						
	Average climate water outlet 35 °C	General	SCOP	4.51 / 4.71						
		ηs (Seasonal space heating efficiency) %	177 / 186							
			Seasonal space heating eff. class	A+++						
Domestic hot water heating	General	Declared load profile		L	XL	L	XL	L	XL	
	Average climate	COP <sub>dhw</sub> η <sub>wh</sub> (water heating efficiency) %		2.86 / 2.85	3.00 / 2.99	2.86 / 2.85	3.00 / 2.99	2.86 / 2.85	3.00 / 2.99	
		Water heating energy efficiency class		124	125	124	125	124	125	
				A+						

Indoor Unit				ETSH	16P30E7	16P50E7	16P30E7	16P50E7	16P30E7	16P50E7
Casing	Colour	Traffic white (RAL9016) / Dark grey (RAL7011)								
	Material	Impact resistant polypropylene								
Dimensions	Unit	HeightxWidthxDepth	mm	1,892x594x644	1,910x792x816	1,892x594x644	1,910x792x816	1,892x594x644	1,910x792x816	
Weight	Unit		kg	75	98	75	98	75	98	
Tank	Water volume		l	294	477	294	477	294	477	
	Maximum water temperature		°C	85						
Operation range	Heating	Ambient	Min.~Max.	-28 ~ 35						
		Water side	Min.~Max.	15 ~ 70						
	Domestic hot water	Ambient	Min.~Max.	-28 ~ 35						
		Water side	Min.~Max.	10 ~ 63						
Sound power level	Nom.		dB(A)	45.6						
Sound pressure level	Nom.		dB(A)	32.8						

Outdoor Unit				EPRA	14DV37/W17	16DV37/W17	18DV37/W17
Dimensions	Unit	HeightxWidthxDepth	mm	1,003x1,270x533			
Weight	Unit		kg	146 / 151			
Compressor	Quantity			1			
	Type			Hermetically sealed scroll compressor			
Operation range	Heating	Min.~Max.	°CDB	-28 ~ 25			
	Domestic hot water	Min.~Max.	°CDB	-28 ~ 35			
Refrigerant	Type			R-32			
	GWP			675			
	Charge		kg	4.20			
	Charge		TCO <sub>2</sub> Eq	2.84			
	Control			Expansion valve			
LW(A) Sound power level (according to EN14825)				54			
Sound pressure level (at 1 meter)	Nom.			43.0		48.0	
Power supply	Name/Phase/Frequency/Voltage		Hz/V	V3/1~/50/230 / W1/3~/50/400			
Current	Recommended fuses		A	32/16			

This product contains fluorinated greenhouse gases.

# Daikin Altherma 3 H MT ECH<sub>2</sub>O

Floor standing air-to-water heat pump for **bivalent heating and hot water** with thermal solar support

- › Integrated solar unit, offering top comfort in heating and hot water
- › Maximum use of renewable energy: uses heat pump technology for heating and solar support for space heating and domestic hot water production
- › Fresh water principle: hygienic water, with no need for thermal legionella disinfection
- › Maintenance-free tank: no corrosion, anode, scale or lime deposits, and no loss of water through safety valve
- › Bivalent system: combinable with a secondary heat source
- › Heat loss is reduced to a minimum thanks to the high quality insulation
- › App control possible for managing heating and hot water operation
- › Heat pump operation down to -28 °C



up to



011-1W0501  
011-1W0502

Efficiency data		ETSHB + EPRA		12P30E + 08EV/W	12P50E + 08EV/W	12P30E + 10EV/W	12P50E + 10EV/W	12P30E + 12EV/W	12P50E + 12EV/W	
Space heating	Average climate water outlet 55 °C	General	SCOP	3.41 / 3.52		3.43 / 3.53				
			η <sub>s</sub> (Seasonal space heating efficiency) %			134 / 138				
			Seasonal space heating eff. class			A++				
Average climate water outlet 35 °C	General	SCOP	4.69 / 4.81		4.71 / 4.84		4.71 / 4.84			
		η <sub>s</sub> (Seasonal space heating efficiency) %	184 / 190		186 / 191		186 / 191			
		Seasonal space heating eff. class			A+++					
Domestic hot water heating	Average climate	General	Declared load profile			L				
			COP <sub>dhw</sub>	2.75 / 2.83		3.10 / 3.17		2.75 / 2.83		3.10 / 3.17
			η <sub>wh</sub> (water heating efficiency) %	116 / 119		128 / 131		116 / 119		128 / 131
Water heating energy efficiency class					A+					
Indoor Unit		ETSHB		12P30E	12P50E	12P30E	12P50E	12P30E	12P50E	
Casing	Colour	Traffic white (RAL9016) / Traffic black (RAL9017)								
	Material	Impact resistant polypropylene								
Dimensions	Unit	HeightxWidthxDepth	mm	1,892x594x644	1,910x792x816	1,892x594x644	1,910x792x816	1,892x594x644	1,910x792x816	
Weight	Unit		kg	76	100	76	100	76	100	
Tank	Water volume		l	294	477	294	477	294	477	
	Maximum water temperature		°C	85						
Operation range	Heating	Ambient	Min.~Max.	°C						
		Water side	Min.~Max.	°C						
	Domestic hot water	Ambient	Min.~Max.	°C						
		Water side	Min.~Max.	°C						
Sound power level	Nom.		dBA	45.6						
Sound pressure level	Nom.		dBA	32.8						
Outdoor Unit		EPRA		08EV3/W1	10EV3/W1	12EV3/W1				
Dimensions	Unit	HeightxWidthxDepth	mm	1,003x1,270x533						
Weight	Unit		kg	118						
Compressor	Quantity			1						
	Type			Hermetically sealed swing compressor						
Operation range	Heating	Min.~Max.	°CDB	-28 ~ 25						
	Domestic hot water	Min.~Max.	°CDB	-28 ~ 35						
Refrigerant	Type			R-32						
	GWP			675						
	Charge		kg	3,25						
	Charge		TCO <sub>2</sub> Eq	2.19						
	Control			Expansion valve						
LW(A) Sound power level (according to EN14825)				53						
Sound pressure level (at 1 meter)	Nom.			40.6/41.1						
Power supply	Name/Phase/Frequency/Voltage		Hz/V	V3/1~/50/230 - W1/3~/50/400						
Current	Recommended fuses		A	32/16						

This product contains fluorinated greenhouse gases.



# Daikin Altherma 3 H HT ECH<sub>2</sub>O

Floor standing air-to-water heat pump for **bivalent heating and hot water** with thermal solar support

- › Integrated solar unit, offering top comfort in heating and hot water
- › Maximum use of renewable energy: uses heat pump technology for heating and solar support for space heating and domestic hot water production
- › Fresh water principle: hygienic water, with no need for thermal legionella disinfection
- › Maintenance-free tank: no corrosion, anode, scale or lime deposits, and no loss of water through safety valve
- › Bivalent system: combinable with a secondary heat source
- › Heat loss is reduced to a minimum thanks to the high quality insulation
- › App control possible for managing heating and hot water operation
- › Heat pump operation down to -28 °C



up to



Efficiency data				ETSHB + EPRA	16P30E7 + 14DV7/W7	16P50E7 + 14DV7/W7	16P30E7 + 16DV7/W7	16P50E7 + 16DV7/W7	16P30E7 + 18DV7/W7	16P50E7 + 18DV7/W7
Space heating	Average climate water outlet 55 °C	General	SCOP	3.58 / 3.57						
			ηs (Seasonal space heating efficiency) %	140						
			Seasonal space heating eff. class	A++						
	Average climate water outlet 35 °C	General	SCOP	4.51 / 4.71						
			ηs (Seasonal space heating efficiency) %	177 / 186						
			Seasonal space heating eff. class	A+++						
Domestic hot water heating	Average climate	General	Declared load profile	L	XL	L	XL	L	XL	
			COPdhw	2.86 / 2.85	3.00 / 2.99	2.86 / 2.85	3.00 / 2.99	2.86 / 2.85	3.00 / 2.99	
			ηwh (water heating efficiency) %	124	125	124	125	124	125	
			Water heating energy efficiency class	A+						
<b>Indoor Unit</b>				<b>ETSHB</b>	<b>16P30E7</b>	<b>16P50E7</b>	<b>16P30E7</b>	<b>16P50E7</b>	<b>16P30E7</b>	<b>16P50E7</b>
Casing	Colour	Traffic white (RAL9016) / Dark grey (RAL7011)								
	Material	Impact resistant polypropylene								
Dimensions	Unit	HeightxWidthxDepth	mm	1,892x594x644	1,910x792x816	1,892x594x644	1,910x792x816	1,892x594x644	1,910x792x816	
Weight	Unit		kg	76	100	76	100	76	100	
Tank	Water volume		l	294	477	294	477	294	477	
	Maximum water temperature		°C	85						
Operation range	Heating	Ambient	Min.~Max.	°C	-28 ~ 35					
		Water side	Min.~Max.	°C	15 ~ 70					
	Domestic hot water	Ambient	Min.~Max.	°C	-28 ~ 35					
		Water side	Min.~Max.	°C	10 ~ 63					
Sound power level	Nom.		dBA	45.6						
Sound pressure level	Nom.		dBA	32.8						
<b>Outdoor Unit</b>				<b>EPRA</b>	<b>14DV37/W17</b>	<b>16DV37/W17</b>	<b>18DV37/W17</b>			
Dimensions	Unit	HeightxWidthxDepth	mm	1,003x1,270x533						
Weight	Unit		kg	146 / 151						
Compressor	Quantity			1						
	Type			Hermetically sealed scroll compressor						
Operation range	Heating	Min.~Max.	°CDB	-28 ~ 35						
	Domestic hot water	Min.~Max.	°CDB	-28 ~ 35						
Refrigerant	Type			R-32						
	GWP			675						
	Charge		kg	4.20						
	Charge		TCO <sub>2</sub> Eq	2.84						
	Control			Expansion valve						
LW(A) Sound power level (according to EN14825)				54						
Sound pressure level (at 1 meter)	Nom.			43.0				48.0		
Power supply	Name/Phase/Frequency/Voltage		Hz/V	V3/1~/50/230 / W1/3~/50/400						
Current	Recommended fuses		A	32/16						

This product contains fluorinated greenhouse gases.

# Daikin Altherma 3 H MT ECH<sub>2</sub>O

Floor standing air-to-water heat pump for **heating, cooling and hot water** with thermal solar support

- › Integrated solar unit, offering top comfort in heating, hot water and cooling
- › Maximum use of renewable energy: uses heat pump technology for heating and solar support for space heating and domestic hot water production
- › Fresh water principle: hygienic water, with no need for thermal legionella disinfection
- › Maintenance-free tank: no corrosion, anode, scale or lime deposits, and no loss of water through safety valve
- › Solar support of domestic hot water with pressureless (drain-back) solar system
- › Heat loss is reduced to a minimum thanks to the high quality insulation
- › App control possible for managing heating, hot water and cooling operation
- › Outdoor unit extracts heat from the outdoor air, even at -28 °C
- › Possible to connect to photovoltaic solar panels to provide energy for your heat pump



Efficiency data				ET SX + EPRA	12P30E + 08EV/W	12P50E + 08EV/W	12P30E + 10EV/W	12P50E + 10EV/W	12P30E + 12EV/W	12P50E + 12EV/W
Space heating	Average climate water outlet 55 °C	General	SCOP	3.47 / 3.59		3.48 / 3.60				
			η <sub>s</sub> (Seasonal space heating efficiency) %	136 / 141						
	Seasonal space heating eff. class			A++						
	Average climate water outlet 35 °C	General	SCOP	4.79 / 4.95		4.82 / 4.98				
η <sub>s</sub> (Seasonal space heating efficiency) %			189 / 195		190 / 196					
Seasonal space heating eff. class			A+++							
Domestic hot water heating	Average climate	General	Declared load profile	L						
			COP <sub>dhw</sub>	2.75 / 2.83	3.10 / 3.17	2.75 / 2.83	3.10 / 3.17	2.75 / 2.83	3.10 / 3.17	
	η <sub>wh</sub> (water heating efficiency) %			116 / 119	128 / 131	116 / 119	128 / 131	116 / 119	128 / 131	
	Water heating energy efficiency class			A+						
Indoor Unit				ET SX	12P30E	12P50E	12P30E	12P50E	12P30E	12P50E
Casing	Colour	Traffic white (RAL9016) / Traffic black (RAL9017)								
	Material	Impact resistant polypropylene								
Dimensions	Unit	HeightxWidthxDepth	mm	1,892x594x644	1,910x792x816	1,892x594x644	1,910x792x816	1,892x594x644	1,910x792x816	
Weight	Unit	kg	75	98	75	98	75	98		
Tank	Water volume	l	294	477	294	477	294	477		
	Maximum water temperature	°C	85							
Operation range	Heating	Ambient	Min.~Max.	°C						
		Water side	Min.~Max.	°C						
	Cooling	Ambient	Min.~Max.	°C						
		Water side	Min.~Max.	°C						
	Domestic hot water	Ambient	Min.~Max.	°C						
		Water side	Min.~Max.	°C						
Sound power level	Nom.	dBA	47.3							
Sound pressure level	Nom.	dBA	38.6							
Outdoor Unit				EPRA	08EV3/W1	10EV3/W1	12EV3/W1			
Dimensions	Unit	HeightxWidthxDepth	mm	1,003x1,270x533						
Weight	Unit	kg	118							
Compressor	Quantity	1								
	Type	Hermetically sealed swing compressor								
Operation range	Heating	Min.~Max.	°CDB							
	Cooling	Min.~Max.	°CDB							
	Domestic hot water	Min.~Max.	°CDB							
Refrigerant	Type	R-32								
	GWP	675								
	Charge	kg	3.25							
	Charge	TCO <sub>2</sub> Eq	2.19							
	Control	Expansion valve								
LW(A) Sound power level (according to EN14825)	53									
Sound pressure level (at 1 meter)	Nom.	40.6/41.1								
Power supply	Name/Phase/Frequency/Voltage	Hz/V	V3/1~/50/230 - W1/3~/50/400							
Current	Recommended fuses	A	32/16							

This product contains fluorinated greenhouse gases.

# Daikin Altherma 3 H HT ECH<sub>2</sub>O

Floor standing air-to-water heat pump for heating, cooling and hot water with thermal solar support

- › Integrated solar unit, offering top comfort in heating, hot water and cooling
- › Maximum use of renewable energy: uses heat pump technology for heating and solar support for space heating and domestic hot water production
- › Fresh water principle: hygienic water, with no need for thermal legionella disinfection
- › Maintenance-free tank: no corrosion, anode, scale or lime deposits, and no loss of water through safety valve
- › Solar support of domestic hot water with pressureless (drain-back) solar system
- › Heat loss is reduced to a minimum thanks to the high quality insulation
- › App control possible for managing heating, hot water and cooling operation
- › Outdoor unit extracts heat from the outdoor air, even at -28 °C
- › Possible to connect to photovoltaic solar panels to provide energy for your heat pump



011-1W0355-356  
011-1W0359-360  
011-1W0363-364

Efficiency data				ET SX + EPRA	16P30E7 + 14DV7/W7	16P50E7 + 14DV7/W7	16P30E7 + 16DV7/W7	16P50E7 + 16DV7/W7	16P30E7 + 18DV7/W7	16P50E7 + 18DV7/W7
Space heating	Average climate water outlet 55 °C	General	SCOP	3.62 / 3.63						
			η <sub>sp</sub> (Seasonal space heating efficiency)	142						
			Seasonal space heating eff. class	A++						
	Average climate water outlet 35 °C	General	SCOP	4.57 / 4.81						
			η <sub>sp</sub> (Seasonal space heating efficiency)	180 / 190						
			Seasonal space heating eff. class	A+++						
Domestic hot water heating	General	Declared load profile		L	XL	L	XL	L	XL	
	Average climate	COP <sub>dhw</sub>		2.86 / 2.85	3.00 / 2.99	2.86 / 2.85	3.00 / 2.99	2.86 / 2.85	3.00 / 2.99	
		η <sub>wh</sub> (water heating efficiency)		124	125	124	125	124	125	
		Water heating energy efficiency class		A+						
Indoor Unit				ET SX	16P30E7	16P50E7	16P30E7	16P50E7	16P30E7	16P50E7
Casing	Colour	Traffic white (RAL9016) / Dark grey (RAL7011)								
	Material	Impact resistant polypropylene								
Dimensions	Unit	HeightxWidthxDepth	mm	1,892x594x644	1,910x792x816	1,892x594x644	1,910x792x816	1,892x594x644	1,910x792x816	
Weight	Unit	kg		75	98	75	98	75	98	
Tank	Water volume	l		294	477	294	477	294	477	
	Maximum water temperature	°C		85						
Operation range	Heating	Ambient	Min.~Max.	°C						
		Water side	Min.~Max.	°C						
	Cooling	Ambient	Min.~Max.	°C						
		Water side	Min.~Max.	°C						
	Domestic hot water	Ambient	Min.~Max.	°C						
		Water side	Min.~Max.	°C						
Sound power level	Nom.	dBA		45.6						
Sound pressure level	Nom.	dBA		32.8						
Outdoor Unit				EPRA	14DV37/W17	16DV37/W17	18DV37/W17			
Dimensions	Unit	HeightxWidthxDepth	mm	1,003x1,270x533						
Weight	Unit	kg		146/151						
Compressor	Quantity	1								
	Type	Hermetically sealed scroll compressor								
Operation range	Heating	Min.~Max.	°CDB							
	Cooling	Min.~Max.	°CDB							
	Domestic hot water	Min.~Max.	°CDB							
Refrigerant	Type	R-32								
	GWP	675								
	Charge	kg		4.20						
	Charge	TCO <sub>2</sub> Eq		2.84						
	Control	Expansion valve								
LW(A) Sound power level (according to EN14825)			54							
Sound pressure level (at 1 meter)	Nom.	43.0						48.0		
Power supply	Name/Phase/Frequency/Voltage	Hz/V		V3/1~/50/230 / W1/3~/50/400						
Current	Recommended fuses	A		32/16						

This product contains fluorinated greenhouse gases.

# Daikin Altherma 3 H MT ECH<sub>2</sub>O

Floor standing air-to-water heat pump for **bivalent heating, cooling and hot water** with thermal solar support

- › Integrated solar unit, offering top comfort in heating and hot water
- › Maximum use of renewable energy: uses heat pump technology for heating and solar support for space heating and domestic hot water production
- › Fresh water principle: hygienic water, with no need for thermal legionella disinfection
- › Maintenance-free tank: no corrosion, anode, scale or lime deposits, and no loss of water through safety valve
- › Bivalent system: combinable with a secondary heat source
- › Heat loss is reduced to a minimum thanks to the high quality insulation
- › App control possible for managing heating and hot water operation



up to



011-1W0501  
011-1W0502

Efficiency data				ETSXB + EPRA	12P30E + 08EV/W	12P50E + 08EV/W	12P30E + 10EV/W	12P50E + 10EV/W	12P30E + 12EV/W	12P50E + 12EV/W
Space heating	Average climate water outlet 55 °C	General	SCOP	3.47 / 3.59		3.48 / 3.60				
			η <sub>s</sub> (Seasonal space heating efficiency) %	136 / 141						
	Seasonal space heating eff. class			A++						
	Average climate water outlet 35 °C	General	SCOP	4.79 / 4.95		4.82 / 4.98				
η <sub>s</sub> (Seasonal space heating efficiency) %			189 / 195		190 / 196					
Seasonal space heating eff. class			A+++							
Domestic hot water heating	General	Declared load profile			L					
		Average COP <sub>dhw</sub>	2.75 / 2.83	3.10 / 3.17	2.75 / 2.83	3.10 / 3.17	2.75 / 2.83	3.10 / 3.17		
	Average climate	General	η <sub>wh</sub> (water heating efficiency) %	116 / 119	128 / 131	116 / 119	128 / 131	116 / 119	128 / 131	
			Water heating energy efficiency class			A+				
Indoor Unit				ETSXB	12P30E	12P50E	12P30E	12P50E	12P30E	12P50E
Casing	Colour	Traffic white (RAL9016) / Traffic black (RAL9017)								
	Material	Impact resistant polypropylene								
Dimensions	Unit	HeightxWidthxDepth	mm	1,892x594x644	1,910x792x816	1,892x594x644	1,910x792x816	1,892x594x644	1,910x792x816	
Weight	Unit		kg	76	100	76	100	76	100	
Tank	Water volume		l	294	477	294	477	294	477	
	Maximum water temperature		°C	85						
Operation range	Heating	Ambient	Min.~Max.	°C						
		Water side	Min.~Max.	°C						
	Cooling	Ambient	Min.~Max.	°C						
		Water side	Min.~Max.	°C						
	Domestic hot water	Ambient	Min.~Max.	°C						
		Water side	Min.~Max.	°C						
Sound power level	Nom.		dBA	47.3						
Sound pressure level	Nom.		dBA	38.6						
Outdoor Unit				EPRA	08EV3/W1	10EV3/W1	12EV3/W1			
Dimensions	Unit	HeightxWidthxDepth	mm	1,003x1,270x533						
Weight	Unit		kg	118						
Compressor	Quantity			1						
	Type			Hermetically sealed swing compressor						
Operation range	Heating	Min.~Max.	°CDB	-28 ~ 25						
	Cooling	Min.~Max.	°CDB	10 ~ 43						
	Domestic hot water	Min.~Max.	°CDB	-28 ~ 35						
Refrigerant	Type			R-32						
	GWP			675						
	Charge		kg	3.25						
	Charge		TCO <sub>2</sub> Eq	2.19						
Control				Expansion valve						
LW(A) Sound power level (according to EN14825)				53						
Sound pressure level (at 1 meter)	Nom.			40.6/41.1						
Power supply	Name/Phase/Frequency/Voltage		Hz/V	V3/1~/50/230 - W1/3~/50/400						
Current	Recommended fuses		A	32/16						

This product contains fluorinated greenhouse gases.

# Daikin Altherma 3 H HT ECH<sub>2</sub>O

Floor standing air-to-water heat pump for **bivalent heating, cooling and hot water** with thermal solar support

- › Integrated solar unit, offering top comfort in heating and hot water
- › Maximum use of renewable energy: uses heat pump technology for heating and solar support for space heating and domestic hot water production
- › Fresh water principle: hygienic water, with no need for thermal legionella disinfection
- › Maintenance-free tank: no corrosion, anode, scale or lime deposits, and no loss of water through safety valve
- › Bivalent system: combinable with a secondary heat source
- › Heat loss is reduced to a minimum thanks to the high quality insulation
- › App control possible for managing heating and hot water operation



up to



011-1W0355-356  
011-1W0359-360  
011-1W0363-364

Efficiency data				ETSXB + EPRA	16P30E7 + 14DV7/W7	16P50E7 + 14DV7/W7	16P30E7 + 16DV7/W7	16P50E7 + 16DV7/W7	16P30E7 + 18DV7/W7	16P50E7 + 18DV7/W7
Space heating	Average climate water outlet 55 °C	General	SCOP	3.62 / 3.63						
			η <sub>s</sub> (Seasonal space heating efficiency) %	142						
	Seasonal space heating eff. class			A++						
	Average climate water outlet 35 °C	General	SCOP	4.57 / 4.81						
η <sub>s</sub> (Seasonal space heating efficiency) %			180 / 190							
Seasonal space heating eff. class			A+++							
Domestic hot water heating	General	Declared load profile			L	XL	L	XL	L	XL
		Average climate	COP <sub>dhw</sub>			2.86 / 2.85	3.00 / 2.99	2.86 / 2.85	3.00 / 2.99	2.86 / 2.85
	η <sub>wh</sub> (water heating efficiency) %			124						
	Water heating energy efficiency class			A+						
Indoor Unit				ETSXB	16P30E7	16P50E7	16P30E7	16P50E7	16P30E7	16P50E7
Casing	Colour	Traffic white (RAL9016) / Dark grey (RAL7011)								
	Material	Impact resistant polypropylene								
Dimensions	Unit	HeightxWidthxDepth	mm	1,892x594x644	1,910x792x816	1,892x594x644	1,910x792x816	1,892x594x644	1,910x792x816	
Weight	Unit		kg	76	100	76	100	76	100	
Tank	Water volume		l	294	477	294	477	294	477	
	Maximum water temperature		°C	85						
Operation range	Heating	Ambient	Min.~Max.	°C						
		Water side	Min.~Max.	°C						
	Cooling	Ambient	Min.~Max.	°C						
		Water side	Min.~Max.	°C						
	Domestic hot water	Ambient	Min.~Max.	°C						
		Water side	Min.~Max.	°C						
Sound power level	Nom.		dBA	45.6						
Sound pressure level	Nom.		dBA	32.8						
Outdoor Unit				EPRA	14DV37/W17	16DV37/W17	18DV37/W17			
Dimensions	Unit	HeightxWidthxDepth	mm	1,003x1,270x533						
Weight	Unit		kg	146/151						
Compressor	Quantity			1						
	Type			Hermetically sealed scroll compressor						
Operation range	Heating	Min.~Max.	°CDB	-28 ~ 25						
	Cooling	Min.~Max.	°CDB	10 ~ 43						
	Domestic hot water	Min.~Max.	°CDB	-28 ~ 35						
Refrigerant	Type			R-32						
	GWP			675						
	Charge		kg	4.20						
	Charge		TCO <sub>2</sub> Eq	2.84						
	Control			Expansion valve						
LW(A) Sound power level (according to EN14825)				54						
Sound pressure level (at 1 meter)	Nom.			43.0				48.0		
Power supply	Name/Phase/Frequency/Voltage		Hz/V	V3/1~/50/230 / W1/3~/50/400						
Current	Recommended fuses		A	32/16						

This product contains fluorinated greenhouse gases.

# Wall mounted unit

## Why choose Daikin wall mounted unit?

The Daikin Altherma 3 split wall mounted unit offers heating and cooling with high flexibility for a quick and easy installation, with an optional connection to deliver domestic hot water.

### High flexibility for installation and domestic hot water connection

- › Inclusion of all hydraulic components means no third party components are required
- › PCB board and hydraulic components are located in the front for easy access
- › Compact dimensions allows for small installation space, as almost no side clearances are required
- › The unit's sleek design blends in with other household appliances
- › Combine with a stainless steel or ECH<sub>2</sub>O thermal store



## Flexibility in providing domestic hot water

If the end user requires hot water and installation height is limited, a separate stainless steel tank provides the required installation flexibility.

ECH<sub>2</sub>O thermal store range: additional hot water comfort

Combine your wall mounted unit with a thermal store for additional hot water comfort.

- › Fresh water principle: receive domestic hot water on demand while eliminating the risk of contamination and sedimentation
- › Optimal domestic hot water performance: with high tapping performance
- › Fit for future possibility to integrate with renewable solar energy and other heat sources, e.g. fireplace
- › Lightweight and robust build on the unit combined with cascade principle offers flexible installation options



## Flexibility in providing space heating

The wall mounted unit is the perfect choice in case the end user is looking for space heating or cooling while domestic hot water is provided by another system.

Example of installation with a stainless steel domestic hot water tank.

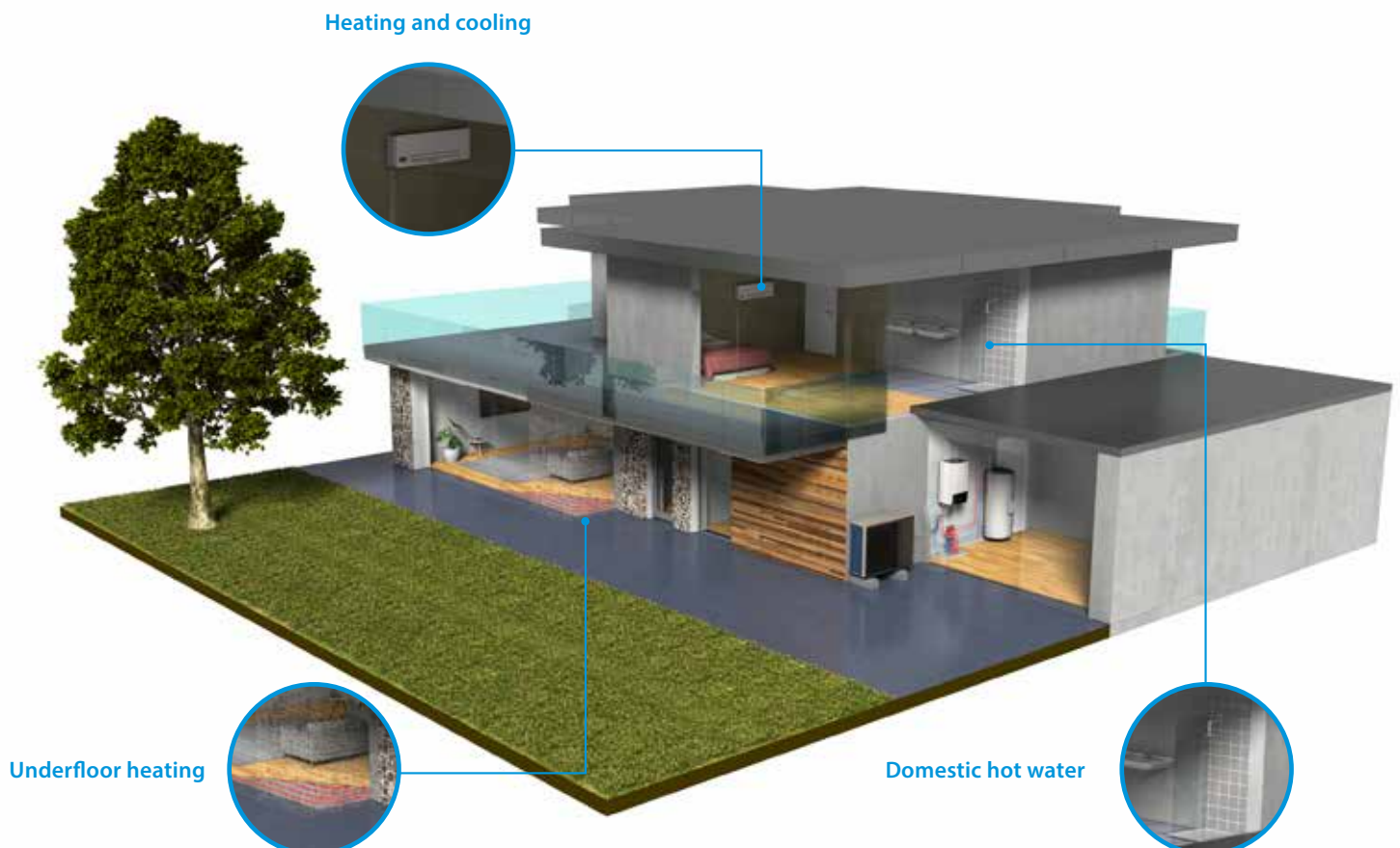

# Daikin Altherma 3 H MT W

Wall mounted **heating only** air-to-water heat pump

- > Inclusion of all hydraulic components means no third party components are required
- > PCB board and hydraulic components are located in the front for easy access
- > Compact dimensions allows for small installation space, as almost no side clearances are required
- > The unit's sleek design blends in with other household appliances
- > Combine with a stainless steel tank or ECH<sub>2</sub>O thermal store
- > Heat pump operation down to -28 °C



up to **A+++** **R-32**



011-1W0506  
011-1W0507  
011-1W0508

Efficiency data				ETBH + EPRA	12E6V + 08EV/W	12E9W + 08EV/W	12E6V + 10EV/W	12E9W + 10EV/W	12E6V + 12EV/W	12E9W + 12EV/W
Space heating	Average climate water outlet 55 °C	General	SCOP	3.41 / 3.52		3.43 / 3.53				
			ηs (Seasonal space heating efficiency)			134 / 138				
	Average climate water outlet 35 °C	General	SCOP	4.69 / 4.81		4.71 / 4.84		4.71 / 4.84		
			ηs (Seasonal space heating efficiency)	184 / 190		186 / 191		186 / 191		
			Seasonal space heating eff. class			A++		A+++		
Indoor Unit				ETBH	12E6V	12E9W	12E6V	12E9W	12E6V	12E9W
Casing	Colour			White + Black						
	Material			Sheet metal						
Dimensions	Unit	HeightxWidthxDepth	mm	840x440x390						
Weight	Unit			36.5						
Operation range	Heating	Ambient	Min.~Max.	-28 ~ 25						
		Water side	Min.~Max.	18 ~ 65						
	Domestic hot water	Ambient	Min.~Max.	-28 ~ 35						
		Water side	Min.~Max.	10 ~ 63						
Sound power level	Nom.			44						
Sound pressure level	Nom.			30						
Outdoor Unit				EPRA	08EV3/W1	10EV3/W1	12EV3/W1			
Dimensions	Unit	HeightxWidthxDepth	mm	1,003x1,270x533						
Weight	Unit			118						
Compressor	Quantity			1						
	Type			Hermetically sealed swing compressor						
Operation range	Heating	Min.~Max.	°CDB	-28 ~ 25						
	Domestic hot water	Min.~Max.	°CDB	-28 ~ 35						
Refrigerant	Type			R-32						
	GWP			675						
	Charge			3.25						
	Charge	TCO <sub>2</sub> Eq		2.19						
	Control			Expansion valve						
LW(A) Sound power level (according to EN14825)					53					
Sound pressure level (at 1 meter)	Nom.			40.6/41.1						
Power supply	Name/Phase/Frequency/Voltage			V3/1~/50/230 - W1/3~/50/400						
Current	Recommended fuses			32/16						

This product contains fluorinated greenhouse gases.



# Daikin Altherma 3 H HT W

Wall mounted **heating only** air-to-water heat pump

- > Inclusion of all hydraulic components means no third party components are required
- > PCB board and hydraulic components are located in the front for easy access
- > Compact dimensions allows for small installation space, as almost no side clearances are required
- > The unit's sleek design blends in with other household appliances
- > Combine with a stainless steel tank or ECH<sub>2</sub>O thermal store
- > Heat pump operation down to -28 °C



up to **A+++** **R-32**



011-1W0353  
011-1W0357  
011-1W0361

Efficiency data				ETBH + EPRA	16E6V7 + 14DV7/DW7	16E9W7 + 14DV7/DW7	16E6V7 + 16DV7/W7	16E9W7 + 16DV7/W7	16E6V7 + 18DV7/DW7	16E9W7 + 18DV7/DW7
Space heating	Average climate water outlet 55 °C	General	SCOP	3.58 / 3.57						
			η <sub>s</sub> (Seasonal space heating efficiency) %	140						
	Seasonal space heating eff. class			A++						
	Average climate water outlet 35 °C	General	SCOP	4.51 / 4.71						
η <sub>s</sub> (Seasonal space heating efficiency) %			177 / 186							
Seasonal space heating eff. class			A+++							
Indoor Unit				ETBH	16E6V7	16E9W7	16E6V7	16E9W7	16E6V7	16E9W7
Casing	Colour			White + Black						
	Material			Sheet metal						
Dimensions	Unit	HeightxWidthxDepth		mm						
Weight	Unit			kg						
Operation range	Heating	Ambient	Min.~Max.	°C						
		Water side	Min.~Max.	°C						
	Domestic hot water	Ambient	Min.~Max.	°C						
		Water side	Min.~Max.	°C						
Sound power level	Nom.			dBA						
Sound pressure level	Nom.			dBA						
Outdoor Unit				EPRA	14DV37/W17	16DV37/W17		18DV37/W17		
Dimensions	Unit	HeightxWidthxDepth		mm						
Weight	Unit			kg						
Compressor	Quantity			1						
	Type			Hermetically sealed scroll compressor						
Operation range	Heating	Min.~Max.		°CDB						
	Domestic hot water	Min.~Max.		°CDB						
Refrigerant	Type			R-32						
	GWP			675						
	Charge			kg						
	Charge			TCO <sub>2</sub> Eq						
	Control			Expansion valve						
LW(A) Sound power level (according to EN14825)				54						
Sound pressure level (at 1 meter)	Nom.			43.0				48.0		
Power supply	Name/Phase/Frequency/Voltage			Hz/V						
Current	Recommended fuses			A						

This product contains fluorinated greenhouse gases.

# Daikin Altherma 3 H MT W

Wall mounted **reversible** air-to-water heat pump

- › Inclusion of all hydraulic components means no third party components are required
- › PCB board and hydraulic components are located in the front for easy access
- › Compact dimensions allows for small installation space, as almost no side clearances are required
- › The unit's sleek design blends in with other household appliances
- › Combine with a stainless steel tank or ECH<sub>2</sub>O thermal store
- › Heat pump operation down to -28 °C



up to

**A+++**

**R-32**



011-1W0506  
011-1W0507  
011-1W0508

Efficiency data				ETBX + EPRA	12E6V + 08EV/W	12E9W + 08EV/W	12E6V + 10EV/W	12E9W + 10EV/W	12E6V + 12EV/W	12E9W + 12EV/W
Space heating	Average climate water outlet 55 °C	General	SCOP	3.47 / 3.59		136 / 141		3.48 / 3.60		
			ηs (Seasonal space heating efficiency)			A++				
	Average climate water outlet 35 °C	General	SCOP	4.79 / 4.95		188 / 195		4.82 / 4.98		
			ηs (Seasonal space heating efficiency)			A+++		190 / 196		
				Seasonal space heating eff. class						
Indoor Unit				ETBX	12E6V	12E9W	12E6V	12E9W	12E6V	12E9W
Casing	Colour			White + Black						
	Material			Sheet metal						
Dimensions	Unit	HeightxWidthxDepth	mm	840x440x390						
Weight	Unit			36,5						
Operation range	Heating	Ambient	Min.~Max.	°C		-28 ~ 25				
		Water side	Min.~Max.	°C		18 ~ 65				
	Cooling	Ambient	Min.~Max.	°C		10 ~ 43				
		Water side	Min.~Max.	°C		5 ~ 22				
	Domestic hot water	Ambient	Max.	°C		-28 ~ 35				
		Water side	Min.~Max.	°C		10 ~ 63				
Sound power level	Nom.			dBA						
Sound pressure level	Nom.			dBA						
Outdoor Unit				EPRA	08EV3/W1	10EV3/W1	12EV3/W1			
Dimensions	Unit	HeightxWidthxDepth	mm	1,003x1,270x533						
Weight	Unit			kg						
Compressor	Quantity			1						
	Type			Hermetically sealed swing compressor						
Operation range	Heating	Min.~Max.	°CDB		-28 ~ 25					
	Cooling	Min.~Max.	°CDB		10 ~ 43					
	Domestic hot water	Min.~Max.	°CDB		-28 ~ 35					
Refrigerant	Type			R-32						
	GWP			675						
	Charge			kg						
	Charge			TCO <sub>2</sub> Eq						
	Control			Expansion valve						
LW(A) Sound power level (according to EN14825)					53					
Sound pressure level (at 1 meter)	Nom.			40,6/41,1						
Power supply	Name/Phase/Frequency/Voltage			Hz/V						
Current	Recommended fuses			A						

This product contains fluorinated greenhouse gases.

# Daikin Altherma 3 H HT W

Wall mounted **reversible** air-to-water heat pump

- › Inclusion of all hydraulic components means no third party components are required
- › PCB board and hydraulic components are located in the front for easy access
- › Compact dimensions allows for small installation space, as almost no side clearances are required
- › The unit's sleek design blends in with other household appliances
- › Combine with a stainless steel tank or ECH<sub>2</sub>O thermal store
- › Heat pump operation down to -28 °C



up to

**A+++**

**R-32**



011-1W0353  
011-1W0357  
011-1W0361

Efficiency data				ETBX + EPRA	16E6V7 + 14DV7/W7	16E9W7 + 14DV7/W7	16E6V7 + 16DV7/W7	16E9W7 + 16DV7/W7	16E6V7 + 18DV7/W7	16E9W7 + 18DV7/W7
Space heating	Average climate water outlet 55 °C	General	SCOP	3.62 / 3.63						
			ηs (Seasonal space heating efficiency)	142						
	Seasonal space heating eff. class			A++						
	Average climate water outlet 35 °C	General	SCOP	4.57 / 4.81						
ηs (Seasonal space heating efficiency)			180 / 190							
Seasonal space heating eff. class			A+++							
Indoor Unit				ETBX	16E6V7	16E9W7	16E6V7	16E9W7	16E6V7	16E9W7
Casing	Colour	White + Black								
	Material	Sheet metal								
Dimensions	Unit	HeightxWidthxDepth	mm							
Weight	Unit	kg								
Operation range	Heating	Ambient	Min.~Max.	°C						
		Water side	Min.~Max.	°C						
	Cooling	Ambient	Min.~Max.	°C						
		Water side	Min.~Max.	°C						
	Domestic hot water	Ambient	Max.	°C						
		Water side	Min.~Max.	°C						
Sound power level	Nom.	dBA								
Sound pressure level	Nom.	dBA								
Outdoor Unit				EPRA	14DV37/W17	16DV37/W17		18DV37/W17		
Dimensions	Unit	HeightxWidthxDepth	mm							
Weight	Unit	kg								
Compressor	Quantity	1								
	Type	Hermetically sealed scroll compressor								
Operation range	Heating	Min.~Max.	°CDB							
	Cooling	Min.~Max.	°CDB							
	Domestic hot water	Min.~Max.	°CDB							
Refrigerant	Type	R-32								
	GWP	675								
	Charge	kg	4.20							
	Charge	TCO <sub>2</sub> Eq	2.84							
	Control	Expansion valve								
LW(A) Sound power level (according to EN14825)	54									
Sound pressure level (at 1 meter)	Nom.	43.0						48.0		
Power supply	Name/Phase/Frequency/Voltage	Hz/V	V3/1~/50/230 / W1/3~/50/400							
Current	Recommended fuses	A	32/16							

This product contains fluorinated greenhouse gases.





# Thermal stores and tanks

## Hot water heating installation options

### Why choose a thermal store or domestic hot water tank?

Whether you only need hot water or you want to combine your hot water with solar systems, we offer you the best solutions to the highest levels of comfort, energy efficiency and reliability.



Thermal store



Stainless steel tank

### Domestic hot water tank

#### Stainless steel tanks

##### Comfort

- › Available in 150, 180, 200, 250 and 300 litres in stainless steel EKHWS(U)-D

##### Efficiency

- › High-quality insulation keeps heat loss to a minimum
- › Efficient temperature heating: from 10 °C to 50 °C in only 60 minutes
- › Available as an integrated solution or separate tank

##### Reliability

- › At necessary intervals, the unit can heat up water up to 60 °C to prevent the risk of bacteria growth



# The ECH<sub>2</sub>O thermal store range

## ECH<sub>2</sub>O thermal store: additional hot water comfort

Combine your monobloc with a thermal store to achieve the ultimate comfort at home.

- › Fresh water principle: receive domestic hot water on demand while eliminating the risk of contamination and sedimentation
- › Optimal domestic hot water performance: the low temperature evolution enables high tapping performance
- › Fit for the future: possibility to integrate with renewable solar energy and other heat sources, e.g. fireplace
- › Lightweight and robust build of the unit combined with the cascade principle offers flexible installation options

Built for small and large homes, customers can choose between a pressureless and a pressurised hot water system.

## Efficiency

- › Fit for the future: maximise renewable energy sources
- › Intelligent Heat Storage Management: ensures continuous heating during defrost mode, and uses stored heat for space heating
- › High-quality insulation keeps heat loss to a minimum

## Reliability

- › Maintenance-free tank: no corrosion, anode, scale or lime deposits, and no water loss through the safety valve

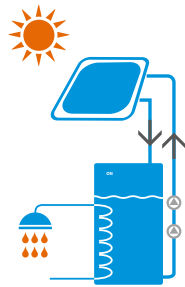

Drain-back solar system

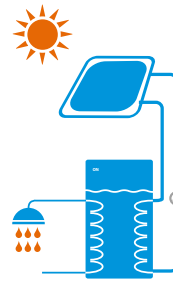

Pressurised solar system

### Pressureless (drain-back) solar system

- › The solar collectors are only filled with water when sufficient heating is provided by the sun
- › The pumps in the control and pump unit switch on briefly and fill the collectors with storage tank water
- › After filling, water circulation is maintained by the remaining pump

### Pressurised solar system

- › System is filled with heat transfer fluid with the correct amount of antifreeze to avoid freezing in winter
- › System is pressurised and sealed

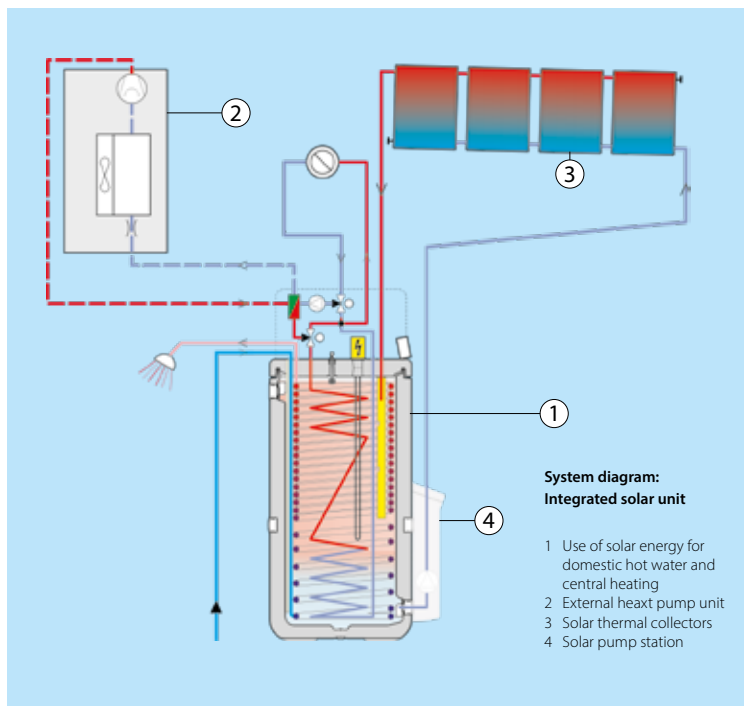

## Monthly energy consumption of an average detached house

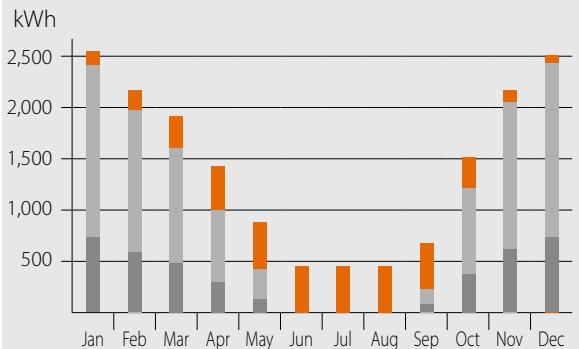

- Utilisation of solar energy for domestic hot water and central heating
- Heat pump (environmental heat)
- Auxiliary energy (electricity)

# Thermal store

## Plastic domestic hot water tank with solar support

- › Tank designed for connection with pressurised thermal solar system
- › Tank designed for connection with drainback thermal solar system
- › Available in 300 and 500 liters
- › Large hot water storage tank to provide domestic hot water at any time
- › Heat loss is reduced to a minimum thanks to the high quality insulation
- › Space heating support possible (500 L tank only)



Accessory		EKHWP	300B	500B	300PB	500PB		
Casing	Colour	Traffic white (RAL9016) / Dark grey (RAL7011)						
	Material	Impact resistant polypropylene						
Dimensions	Unit	Width	mm	595	790	595	790	
		Depth	mm	615	790	615	790	
Weight	Unit	Empty	kg	58	82	58	89	
Tank	Water volume		l	294	477	294	477	
	Material		Polypropylen					
	Maximum water temperature		°C	85				
	Insulation	Heat loss	kWh/24h	1.5	1.7	1.5	1.7	
	Energy efficiency class		B					
	Standing heat loss		W	64	72	64	72	
Storage volume		l	294	477	294	477		
Heat exchanger	Domestic hot water	Quantity		1				
		Tube material		Stainless steel (DIN 1.4404)				
		Face area	m²	5,600	5,800	5,600	5,900	
		Internal coil volume	l	27.1	28.1	27.1	28.1	
		Operating pressure	bar	6				
		Average specific thermal output	W/K	2,790	2,825	2,790	2,825	
	Charging	Quantity		1				
		Tube material		Stainless steel (DIN 1.4404)				
		Face area	m²	3	4	3	4	
		Internal coil volume	l	13	18	13	18	
		Operating pressure	bar	3				
		Average specific thermal output	W/K	1,300	1,800	1,300	1,800	
	Pressurised solar	Average specific thermal output		W/K	-	390	840	
	Auxiliary solar heating	Tube material		-	Stainless steel (DIN 1.4404)	-	Stainless steel (DIN 1.4404)	
Face area		m²	-	1	-	1		
Internal coil volume		l	-	4	-	4		
Operating pressure		bar	-	3	-	3		
Average specific thermal output		W/K	-	280	-	280		



# Domestic hot water tank

## Stainless steel domestic hot water tank

› Available in 150, 180, 200, 250 and 300 litres in stainless steel  
EKHWS(U)-D



EKHWS(U)-D

Accessory		EKHWS	150(U)D3V3	180(U)D3V3	200(U)D3V3	250(U)D3V3	300(U)D3V3
Casing	Colour		Neutral white				
	Material		Epoxy coated steel / Epoxy-coated mild steel				
Weight	Unit	kg	45	50	53	58	63
	Empty						
Tank	Water volume	l	145	174	192	242	292
	Material		Stainless steel (EN 1.4521)				
	Maximum water temperature	°C	75				
	Insulation Heat loss	kWh/24h	1.1	1.2	1.3	1.4	1.6
	Energy efficiency class		B				
	Standing heat loss	W	45	50	55	60	68
	Storage volume	l	145	174	192	242	292
	Heat exchanger	Domestic hot water	Quantity	1			
		Tube material	Stainless steel (EN 1.4521)				
		Face area	m <sup>2</sup>	1,050	1,400		1,800
		Internal coil volume	l	4.9	6.5		8.2
		Operating pressure	bar	10			
Booster heater	Capacity	kW	3				
Power supply	Phase/Frequency/Voltage	Hz/V	1~/50/230				

# Daikin Altherma HPC Floor standing model



The floor standing heat pump convector impresses with its low sound operations, and its slim design that received the RedDot Award 2020. Next to heating and cooling, the unit can also provide indoor air quality control.

## Why Indoor Air Quality Matters

Indoor Air Quality (IAQ) refers to the air quality in a building or structure, breathed in every day by the building's occupants.

When planning new residential buildings, schools, offices or light commercial buildings, many things must be considered. Besides structural factors, there are also the topics of heating, cooling and something often neglected: indoor air quality.

Did you know that the indoor air we breathe, whether at home, at the office, or in a hotel room could in fact be much more polluted than the air outside?

- › 90 % of our lives is spent indoors
- › Indoor air quality can be 2 to 5 times worse than outdoor air quality because of pollutants, such as pollen, bacteria, etc.



## How does Daikin Altherma HPC ensure a healthy and comfortable indoor air quality?

When a pollutant level of indoor air is reached, the IAQ sensor opens a damper, which allows fresh air to come in. The incoming fresh air is immediately heated or cooled (depending on the demand) by the heat pump convector. In this way the indoor air remains of good quality while comfort is ensured.

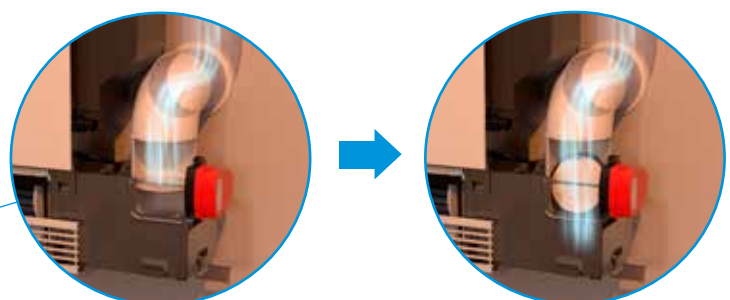
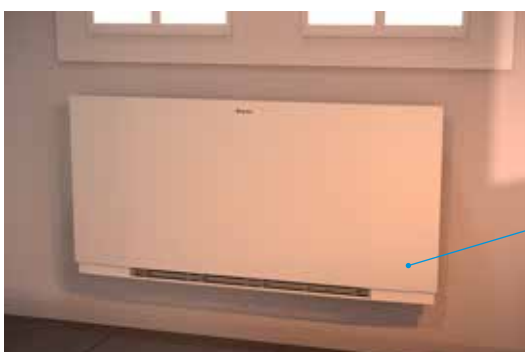



## Slim design



The floor standing Daikin Altherma HPC has a depth of only 135 mm that fits any house or apartment. Its optimised design was rewarded with the Reddot Design Award 2020.

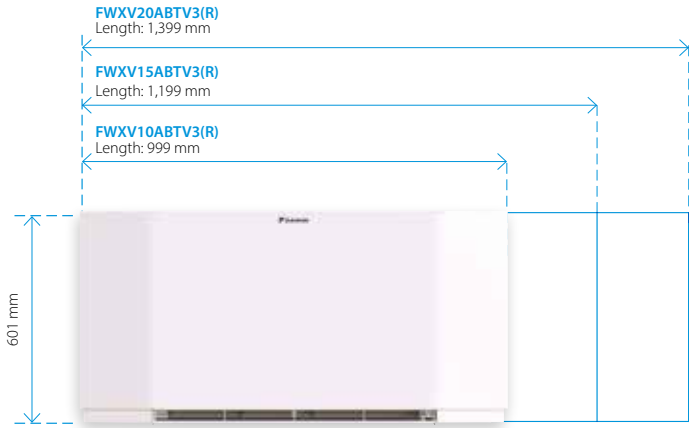

## Fast and high capacity

The Daikin Altherma HPC combines the advantages of residential underfloor heating and radiators. It delivers high-capacity heating or cooling faster and can be set at ultra-low temperatures (35/30 °C regime).





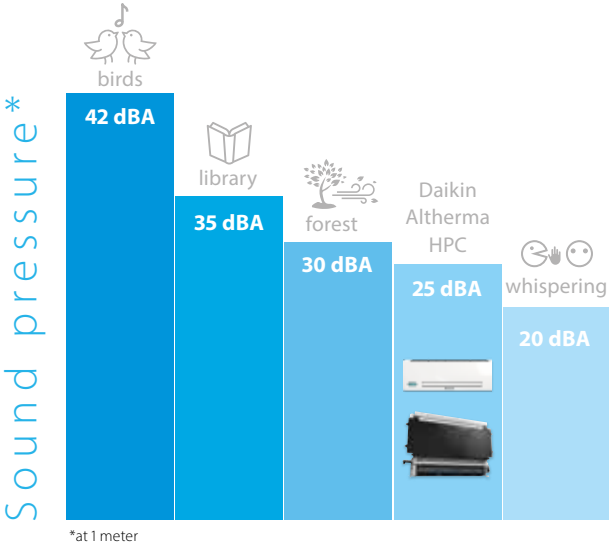

## Discreet

As the unit reaches its set point, a continuous modulating fan gradually reduces its speed and creates less noise. For the wall mounted and concealed units, the sound pressure measures 25dB(A) at 1m when the fan is on low-speed setting. Even lower sound pressure in super-silent mode (night mode).



## Controls

Daikin offers a wide variety of controllers that are functional and have a great design.

- EKRTCTRL1**

  - > Built-in controller
  - > Fully modulating
  - > Multicolor display
- EKRTCTRL2**

  - > Built-in controller
  - > 4 speed settings
- EKWHCTRL1**

  - > Wall controller
  - > Fully modulating
  - > In combination with EKWHCTRL0
- EKPCBO**

  - > Built-in controller
  - > ON/OFF
  - > In combination with external thermostats
- EKWHCTRL1A**

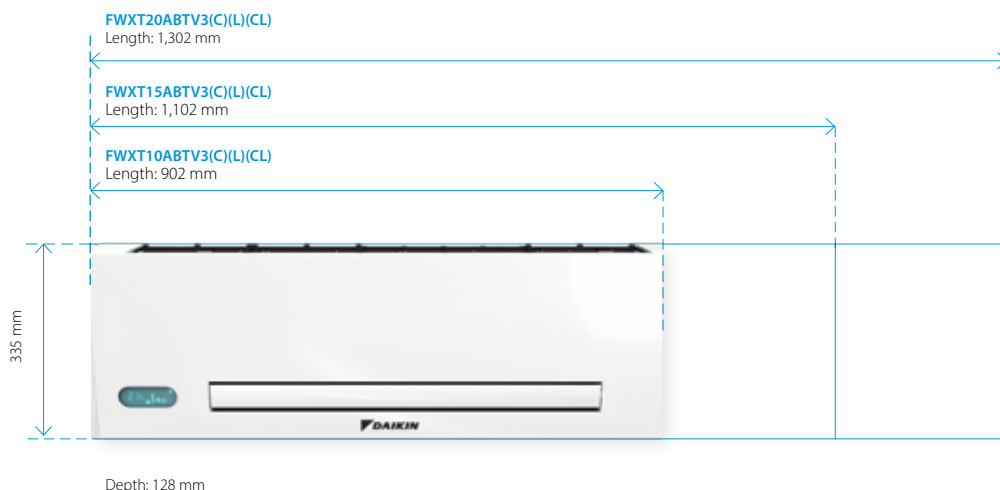
  - > Wall controller
  - > Fully modulating
  - > In combination with EKWHCTRL0
  - > Includes indoor air quality sensor



Thanks to its slim design, our wall-mounted unit blends in with your interior discreetly while helping you save valuable floor space.

## Slim design

Daikin Altherma HPC is a compact unit made of a design metal casing including all valves.



## Controls

Choice of:

- > Fully modulating controller allowing for remote control of the unit.
- > Infrared remote controller and on-board touch panel.

### EKWHCTRL1



- > Wall controller
- > Fully modulating
- > For models FWXT-ABTV3(L)

### Infrared remote controller



- > Remote
- > Fully modulating
- > For models FWXT-ABTV3C(L)

## Compactness



- 1 Slim depth**  
The depth of 128 mm is an outstanding technical achievement that ensures a perfect fit in any home.
- 2 More space for valves**  
Ease of installation: the space for hydraulic valves is wide and easily accessible.

- 3 Modulated airflow**  
When there is less heating demand, the unit modulates its airflow to slow down the fan rate, and in the process, lowers the operational sound.



Forget about your heating or cooling installation altogether: our concealed model vanishes into the wall or ceiling for visual comfort while preserving its unique heating and cooling capabilities.

## Slim design

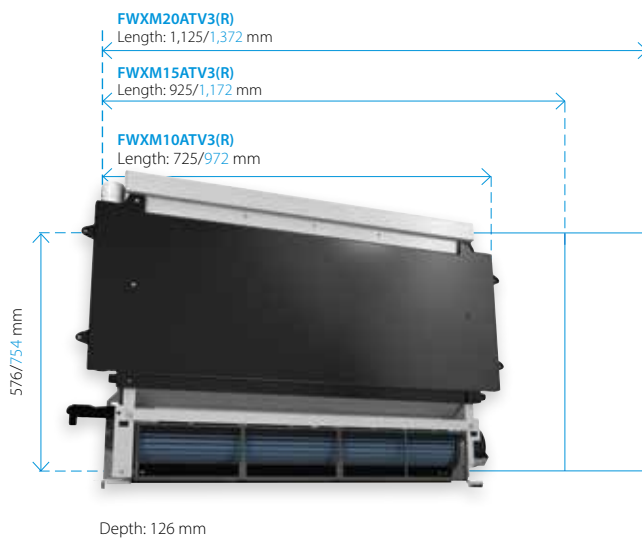

Blue dimensions are for the front cover.

## Controls

### EKWHCTRL1



- > Wall controller
- > Fully modulating
- > In combination with EKWHCTRL0

## Flexible installation

Daikin Altherma HPC can be installed in four different ways, allowing you to install it in almost all conditions. The unit can be positioned horizontally or vertically. For horizontal, in-ceiling installation, three different possibilities are offered:

- > Horizontal cover panel and vertical grille for air outlet
- > Horizontal intake grille and vertical grille for air outlet
- > Horizontal intake and outlet grilles



# Onecta App

Now available with voice control

The Onecta App is for those who live their life on the go and who want to manage their heating system from their smartphone.



# onecta

**NEW**

## Voice control

To provide users with even more comfort and ease, the Onecta App now offers voice control. This hands-free feature cuts down on clicks to manage units faster than ever before.

Cross-functional and multilingual, voice control pairs well with any smart device, including Google Assistant and Amazon Alexa.

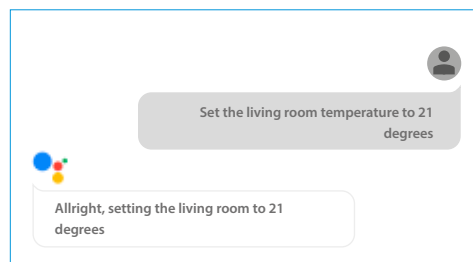

Example of using the voice control via Google Assistant

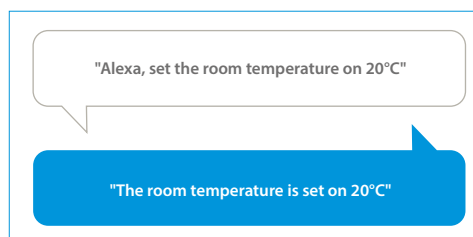

Example of using the voice control via Amazon Alexa

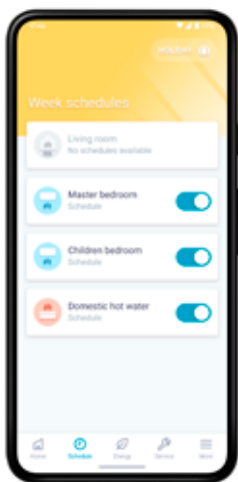

## Schedule

Set up a programme outlining when the system should operate, and create up to six actions per day.

- Schedule room temperature and operation mode
- Enable holiday mode to save costs

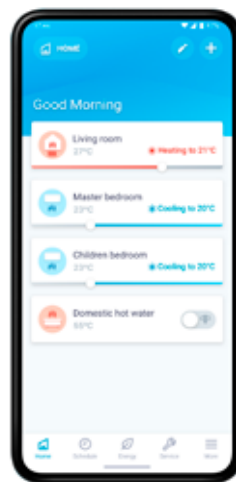

## Control

Customise the system to fit your lifestyle and year-round comfort levels.

- Change room and domestic hot water temperature
- Turn on powerful mode to boost hot water production



## Monitor

Receive a thorough overview of how the system is performing and how much energy it consumes.

- Check the status of the heating system
- Access energy consumption graphs (day, week, month)

Function availability depends on the system type, configuration and operation mode. The app functionality is only available if both the Daikin system and the app have a reliable internet connection.



Scan the QR code to download the app now



# User-friendly wired remote controller with premium design

Madoka. The beauty of simplicity

Madoka



**Black**  
RAL 9005 (matt)  
BRC1HHDK



**White**  
RAL9003 (glossy)  
BRC1HHDW



**Silver**  
RAL 9006 (metallic)  
BRC1HHDS

## Madoka combines refinement and simplicity

- > Sleek and elegant design
- > Intuitive touch-button control
- > Three colours to match any interior
- > Compact: measures only 85 x 85 mm

## Easy update via Bluetooth

It is strongly recommended to make sure that the user interface is up to date. To update the software or check if updates are available, all you need is a mobile device and the Madoka Assistant app. The app is available on Google Play and in the App Store.



## Award-winning design

Madoka received an IF Design Award and Reddot Product Design Award for its innovative design. These awards represent two of the most prestigious and largest design competitions in the world.



reddot award 2018  
winner







# Stand By Me, a journey to customer satisfaction

It's time to relax. With your customer's new Daikin installation and Stand By Me service program, you can rest assured they are benefiting from the best comfort, energy efficiency, usability and service available on the market. Stand By Me eliminates your clients' worries and provides them with a free, extended warranty, quick follow-up from Daikin service providers, and additional warranties for specific parts.

## Get on board on our train to ultimate customer satisfaction

On our underground map you can discover all the tools we offer to Daikin installers to help them from the first point of contact with a new client, to the maintenance and repair after installation.



**HSN**  
PRO

**Heating Solutions Navigator**  
Provide the best fit solution for your customers homes

 Web portal  Professionals



**Daikin e-Care**  
Access to registration, configuration and trouble shooting

 Mobile app  Professionals



**Stand By Me**  
Manage your installation database and offer comfort and service to your customer

 Web portal  Professionals



**Onecta App**  
End-user app to control the residential unit

 Mobile app  Consumer

## Discover the new features

We keep investing in the support towards our installers. With your Daikin account, you have access to Stand By Me and the Heating Solutions Navigator online. Use the same account to access the Daikin e-Care app. The tools offer now new features, check it out!



### Heating Solutions Navigator

Newest functions:  
underfloor heating, Fan Coil selection tool and ventilation quotation tool



### Onecta App

Newest function:  
voice control thanks to Amazon Alexa or Google Assistant



### Stand By Me

Newest function:  
20 installer settings for remote monitoring (SBM Pro)



### Daikin e-Care

Newest function:  
20 installer settings to solve problems remotely

## Error notification and 20 installer settings for remote support through SBM Pro and e-care app

From the professional portal, installers can activate the remote monitoring allowing them to supervise your installation on multiple parameters, from their location. They will get an automatic notification in case there is something wrong with the installation. By changing certain settings they can improve your comfort immediately. Save time and get a better support, thanks to these new features.

- Space heating/cooling
- Main zone & Additional zone (LWT)
- Domestic hot water
- Room (RT)
- Installer – Error handling

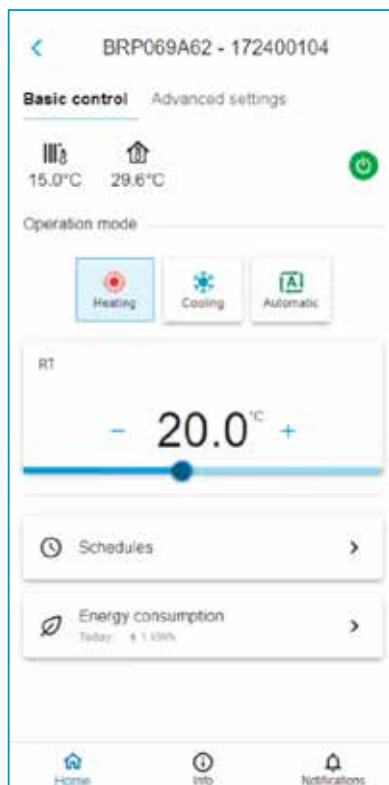

Adjust a room setpoint remotely

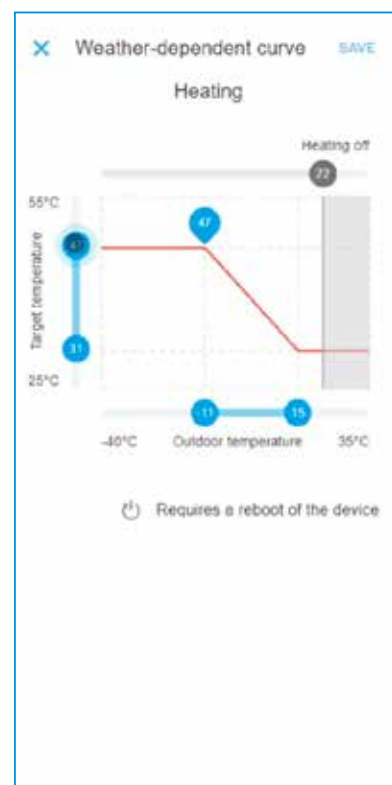

Adjust the weather-dependent curve remotely

# All about the Heating Solutions Navigator

The Heating Solutions Navigator is a digital toolbox developed for Daikin professionals with the aim to assist in providing the best fit solution for your customers homes. With this tool you can configure your installation, create custom made piping & wiring diagrams, set the configuration on your installation and much more.

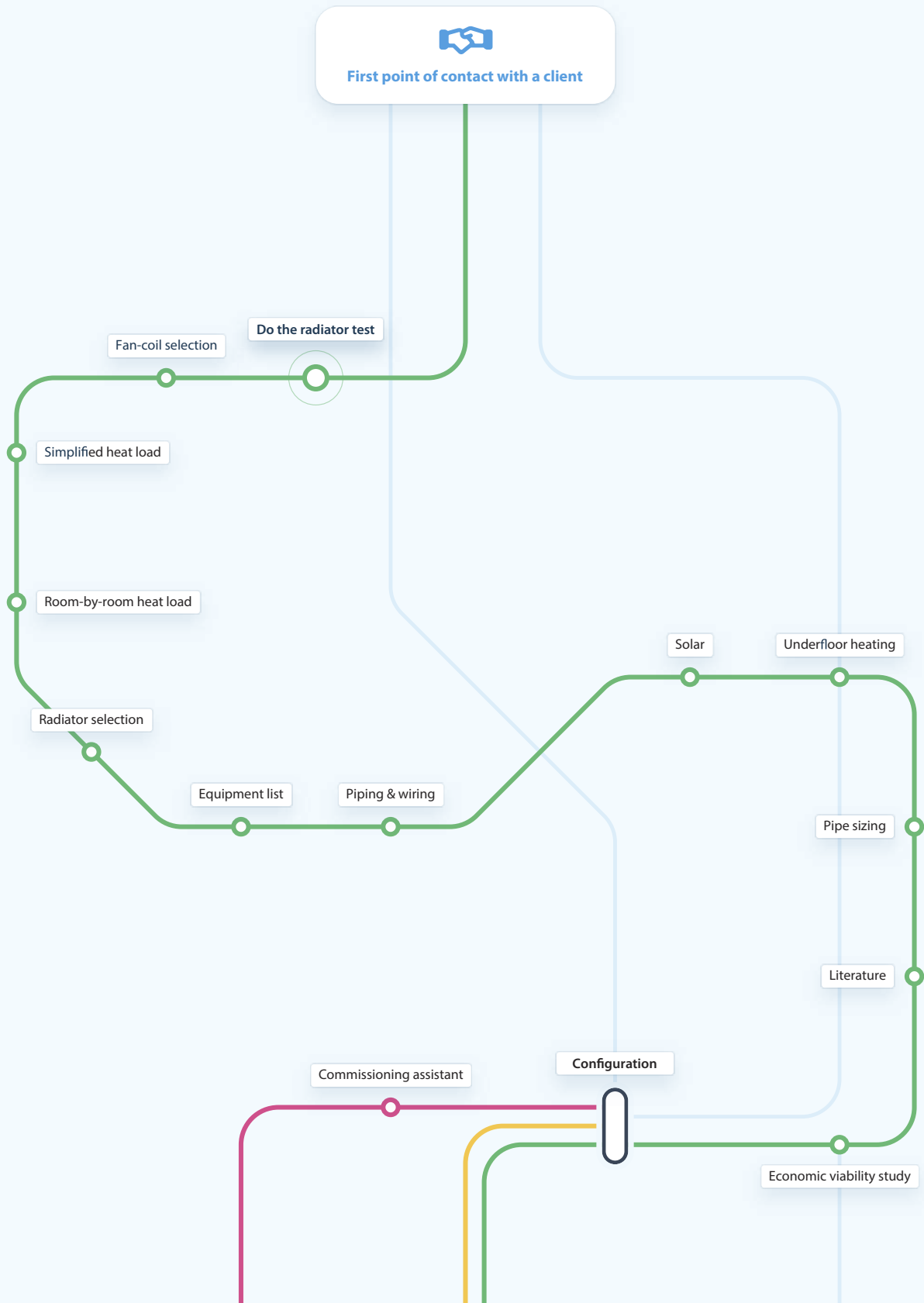

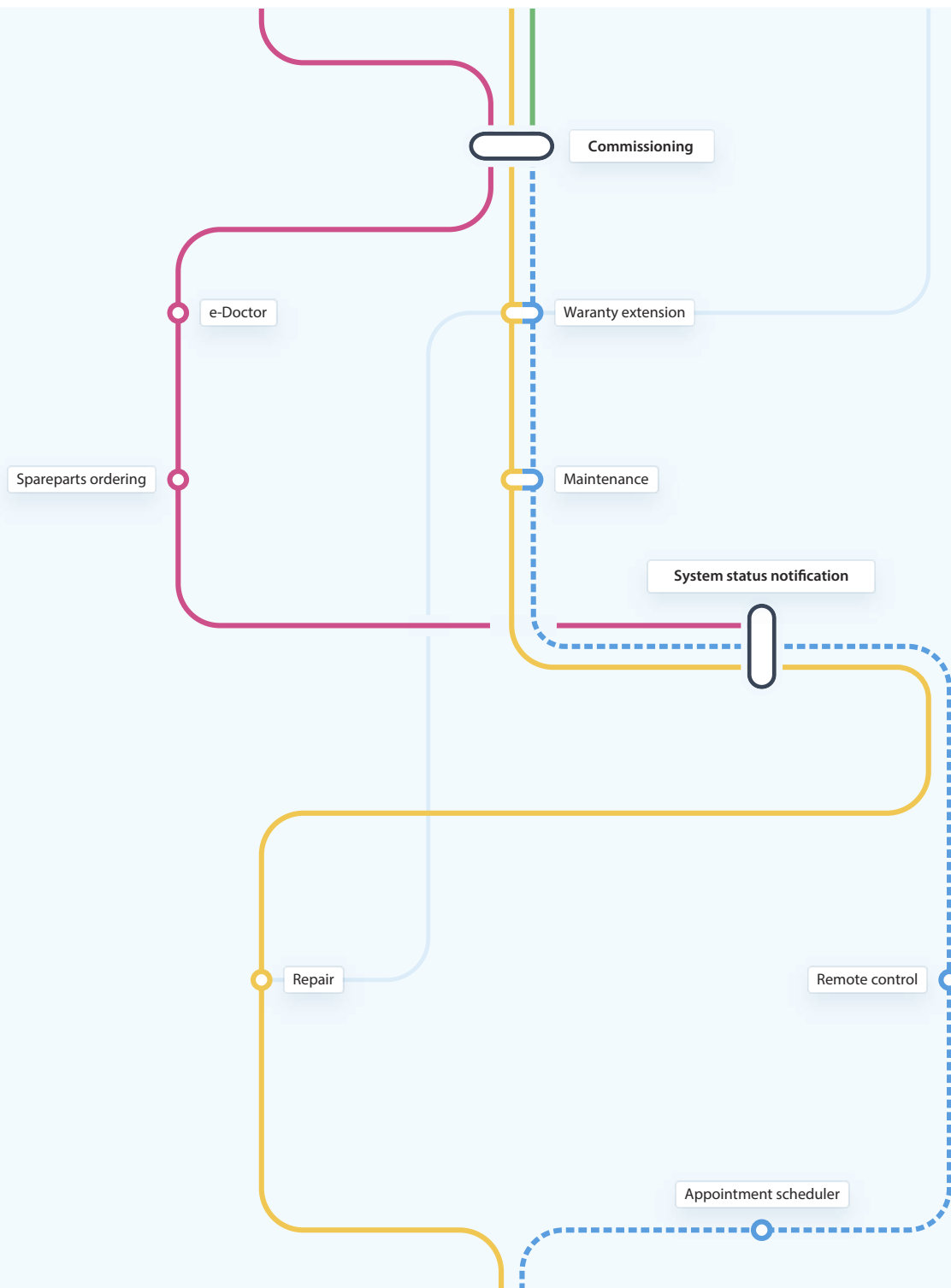

**Heating Solutions Navigator**

- Do the radiator test
- Fan-coil selection
- Simplified Heat load
- Room by Room heat load
- Commissioning assistant
- Equipment list
- Piping & wiring
- Solar
- Underfloor heating
- Pipe sizing
- Literature
- Economic viability study
- Configuration
- Commissioning

**e-Care Mobile App**

- Commissioning assistant
- Commissioning
- e-Doctor
- Spareparts ordering
- System status notifications

**Stand By Me**

- Configuration
- Commissioning
- Warranty extension
- System status notifications

**Onecta App**

- Warranty extension
- Maintenance
- Remote control
- Appointment scheduler

# Combination table and options

			H/O	
			3 H MT	3 H HT
			ETVH12S18E6V	ETVH16S18E6V7
			ETVH12S18E9W	ETVH16S18E9W7
			ETVH12S23E6V	ETVH16S23E6V7
Type	Description	Material name	ETVH12S23E9W	ETVH16S23E9W7
Outdoor unit		EPRA08EV3/W1	●	
		EPRA10EV3/W1	●	
		EPRA12EV3/W1	●	
		EPRA14DV37/W17		●
		EPRA16DV37/W17		●
		EPRA18DV37/W17		●
Controller	Madoka wired room thermostat	BRC1HHDK/S/W	●	●
	Wireless room thermostats	EKRTRB	●	●
	Wired digital thermostat	EKRRTWA	●	●
	WLAN module	BRP069A71	●	●
	WLAN cartridge	BRP069A78	● (1)	● (1)
	Wired digital thermostat	EKWCTRDIV3	●	●
	Wired analog thermostat	EKWCTRANIV3	●	●
	Valve actuator	EKWCVATRIV3	●	●
	Wired underfloor heating base station	EKWUFHTAIV3	●	●
Universal centralized controller	EKCC8-W, DCOM-LT/IO, LT/MB	●	●	
Domestic hot water	Stainless steel tank	EKHWS(U)150D3V3		
		EKHWS(U)180D3V3		
		EKHWS(U)200D3V3		
		EKHWS(U)250D3V3		
	Polypropylene tank	EKHWP300B		
		EKHWP500B		
		EKHWP300PB		
		EKHWP500PB		
	Third party tank kit	EKHY3PART		
		EKHY3PART2		
Sensors	External sensor for EKTRR room thermostat	EKRTETS	●	●
	High voltage smart grid relay kit	EKRELSG	●	●
	Remote indoor temperature sensor	KRCS01-1	● (6)	● (6)
	Remote outdoor temperature sensor	EKRSCA1	● (6)	● (6)
Bizone kits	Generic Bizone kit (PCB only)	EKMIKPOA	●	
	Generic Bizone kit	EKMIKPHA	●	
Other options	Digital I/O PCB	EKRPIHBA	● (7)	● (7)
	Demand PCB	EKRPIAHT	●	●
	PC USB cable	EKPCAB4	●	●
	Conversion kit H/O to reversible for floor standing	EKHVCONV4		●
	Conversion kit H/O to reversible for wall mounted	EKHBCONV	●	
	Booster heater kit	EKBH3SD		
ECH <sub>2</sub> O options	Freeze protection valve	AFVALVE1	●	●
	Inline BUH - connection kit	EKECBUCO1AF		
	Inline BUH - 3kW, for *3V (1N~, 230 V, 3 kW)	EKECBUAF3V		
	Inline BUH - 6kW, for *6V (1N~, 230 V, 6 kW)	EKECBUAF6V		
	Inline BUH - 9kW, for *9WN (3N~, 400 V, 9 kW)	EKECBUAF9W		
	Caleffi sludge and magnetite separator SAS1	156021		
	Biv Connector Kit	EKECBIVCO1AF		
DB connector Kit	EKECDBC01AF			

(1) Included in accessory bag.

(2) Dedicated connection kit: EKEPRHLT3HX.

(3) Dedicated connection kit: ETBH: EKEPRHLTSH / ETBX: EKEPRHLT5X.

(4) EKHY3PART can be used if you have a tank in which you can insert the thermistor.

(5) EKHY3PART2 can be used if you have a tank in which you can't insert a thermistor.

(6) Only one sensor can be connected: indoor or outdoor.

(7) Additional relays to allow bivalent control in combination with external room thermostat are field supply.

(8) Only 1 Backup heater can be connected on one unit: 3 or 6\* or 9 kW (\*No 6T1-model applicable). EKECBUCO1AF is needed to connect the backup heater to the main unit.

(9) Only bivalent models.

(10) Only needed for 300 models. 500 models do not need DB connector kit to install DB solar system.

Floor standing integrated stainless steel tank				Floor standing integrated ECH <sub>2</sub> O		Wall mounted			
Reversible		Bizone				H/O		Reversible	
3 H MT	3 H HT	3 H MT	3 H HT	3 H MT	3 H HT	3 H MT	3 H HT	3 H MT	3 H HT
ETVX12S18E6V	ETVX16S18E6V7	ETVZ12S18E6V	ETVZ16S18E6V7	ETSH(B)12P30E	ETSH(B)16P30E7				
ETVX12S18E9W	ETVX16S18E9W7	ETVZ12S18E9W	ETVZ16S18E9W7	ETSH(B)12P50E	ETSH(B)16P50E7				
ETVX12S23E6V	ETVX16S23E6V7	ETVZ12S23E6V	ETVZ16S23E6V7	ETSX(B)12P30E	ETSX(B)16P30E7	ETBH12E6V	ETBH16E6V7	ETBX12E6V	ETBX16E6V7
ETVX12S23E9W	ETVX16S23E9W7	ETVZ12S23E9W	ETVZ16S23E9W7	ETSX(B)12P50E	ETSX(B)16P50E7	ETBH12E9W	ETBH16E9W7	ETBX12E9W	ETBX16E9W7
●		●		●		●		●	
●		●		●		●		●	
●		●		●		●		●	
	●		●		●		●		●
	●		●		●		●		●
	●		●		●		●		●
●	●	●	●	●	●	●	●	●	●
●	●	●	●	●	●	●	●	●	●
●	●	●	●	●	●	●	●	●	●
●	●	●	●	●	●	●	●	●	●
●	●	●	●	●	●	●	●	●	●
● (1)	● (1)	● (1)	● (1)	● (1)	● (1)	● (1)	● (1)	● (1)	● (1)
●	●	●	●	●	●	●	●	●	●
●	●	●	●	●	●	●	●	●	●
●	●	●	●	●	●	●	●	●	●
●	●	●	●	●	●	●	●	●	●
●	●	●	●	●	●	●	●	●	●
						●	●	●	●
						●	●	●	●
						●	●	●	●
						●	●	●	●
						●	●	●	●
						●	●	●	●
						●	●	●	●
						● (2)	● (2)	● (2)	● (2)
						● (3)	● (3)	● (3)	● (3)
						● (2)	● (2)	● (2)	● (2)
						● (3)	● (3)	● (3)	● (3)
						● (4)	● (4)	● (4)	● (4)
						● (5)	● (5)	● (5)	● (5)
●	●	●	●	●	●	●	●	●	●
●	●	●	●	●	●	●	●	●	●
● (6)	● (6)	● (6)	● (6)	● (6)	● (6)	● (6)	● (6)	● (6)	● (6)
● (6)	● (6)	● (6)	● (6)	● (6)	● (6)	● (6)	● (6)	● (6)	● (6)
●				●	●	●		●	
●				●	●	●		●	
● (7)	● (7)	● (7)	● (7)			● (7)	● (7)	● (7)	● (7)
●	●	●	●	●	●	●	●	●	●
●	●	●	●	●	●	●	●	●	●
		●				●	●		●
●	●	●	●	●	●	●	●	●	●
				●	●				●
				● (8)	● (8)				
				● (8)	● (8)				
				● (8)	● (8)				
				●	●				
				● (9)	● (9)				
				● (10)	● (10)				



**Daikin Europe N.V.** Naamloze Vennootschap Zandvoordestraat 300 · 8400 Oostende · Belgium · [www.daikin.eu](http://www.daikin.eu) · BE 0412 120 336 · RPR Oostende (Publisher)

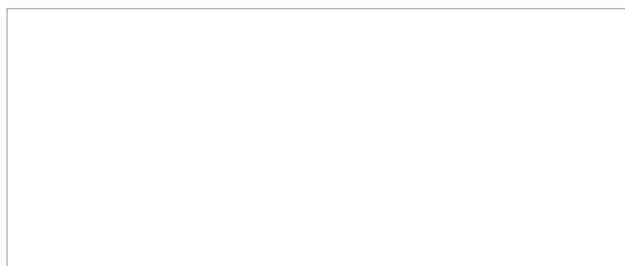

ECPEN22-767B

09/22



The present publication is drawn up by way of information only and does not constitute an offer binding upon Daikin Europe N.V. Daikin Europe N.V. has compiled the content of this publication to the best of its knowledge. No express or implied warranty is given for the completeness, accuracy, reliability or fitness for particular purpose of its content and the products and services presented therein. Specifications are subject to change without prior notice. Daikin Europe N.V. explicitly rejects any liability for any direct or indirect damage, in the broadest sense, arising from or related to the use and/or interpretation of this publication. All content is copyrighted by Daikin Europe N.V.

Printed on non-chlorinated paper.